

**RÄDER-VOGEL®**

FOR BETTER WHEELS AND BETTER SERVICE

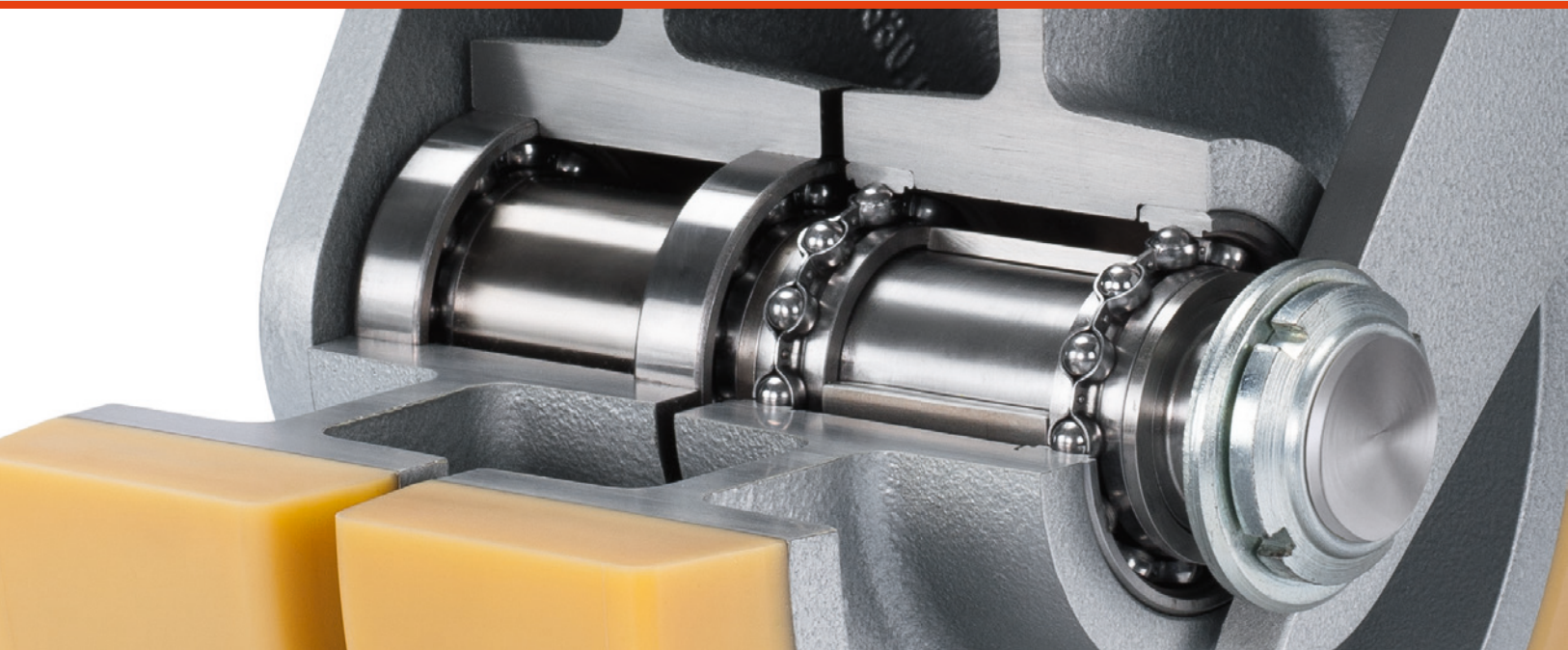

**CATALOGUE**



“We develop and produce wheels and castors that serve a wide range of industries. Products, that offer our customers security and reliability. Our claim is to achieve the highest quality and perfection down to the smallest detail.”

# Contents

## RÄDER-VOGEL

Rediscover the wheel .....	6
----------------------------	---

## WHEEL TREAD MATERIALS

Overview of wheel tread materials .....	18
VULKOLLAN® (93° Shore A) .....	21
VULKOLLAN® hydrolysis-stabilised .....	21
PEVODYN® .....	21
PEVOPUR® .....	21
VULKOLLAN® (95° Shore A) .....	22
VULKOSOFT® .....	22
VULKOLLAN®-ELF .....	22
TRACTOTHAN® .....	23
TRACTOSOFT® .....	23
VULKOLLAN®-Quarz .....	23
VULKODYN® .....	24
PEVODYN®-Soft .....	24
PEVOSOFT® .....	24

## WHEEL TREAD MATERIALS FOR INDUSTRIAL CASTORS

PEVOLON® .....	25
PAG .....	25
PEVOLON®-ELF .....	26
PEVOLASTIC® .....	26
PEVOTHAN® .....	26
PEVOTHAN®-ELF .....	27
Rubber .....	27

## INDUSTRIAL TRUCKS

Applications .....	28
--------------------	----

## CUSTOM-MADE PRODUCTS

Applications .....	30
--------------------	----



34

### PEVOLON®

Contents.....	35
Wheels .....	36
Castors .....	41



48

### PEVOLASTIC®/PEVOTHAN®

Contents.....	49
Wheels .....	50
Castors .....	54



58

### RUBBER WHEELS AND CASTORS

Contents.....	59
Wheels .....	60
Castors .....	69



78

### ELECTRICALLY CONDUCTIVE WHEELS AND CASTORS

Contents.....	79
Wheels .....	80
Castors .....	83



90

**VULKOLLAN®/PEVOPUR®/  
PEVODYN®/  
PEVODYN®-Soft**

Contents..... 91  
Wheels ..... 92  
Castors ..... 100



148

**PROFILE ROLLERS**

Contents..... 149  
Grooved and  
flanged wheels..... 150  
Single-flanged wheels ..... 151



114

**STAINLESS  
STEEL CASTORS**

Contents..... 115  
Castors ..... 116



154

**PALLET ROLLERS**

Contents..... 155  
PEVOLON® ..... 156  
VULKOLLAN® ..... 158  
PEVOPUR® ..... 161  
PEVODYN®-Soft ..... 163



128

**INSTITUTIONAL WHEELS  
AND CASTORS**

Contents..... 129  
Wheels ..... 130  
Castors ..... 132



164

**PRESS-ON TYRES**

Contents..... 165  
VULKOLLAN® ..... 166  
PEVOPUR® ..... 169  
Solid rubber ..... 170



136

**CONVEYOR/ GUIDING  
ROLLERS AND BALL UNITS**

Contents..... 137  
Conveyor rollers..... 138  
Guiding rollers..... 143  
Ball units ..... 144

**TECHNICAL INFORMATION**

Product information ..... 172  
Pictographs ..... 173





## REDISCOVER THE WHEEL

All wheels have one thing in common: they are round. However, each area of application has specific requirements in terms of size, materials and load capacity. Since 1946, we have been developing wheels and castors which meet the ever-increasing demands of the market – from individual customer-specific items to standardised large batches, and for use in industrial trucks, extraction technology, storage technology or in industry, retail and handcraft.

Our high demands, our quality and our capacity for innovation have made us one of the leading manufacturers of wheels, pallet castors, press-on tyres as well as swivel and fixed castors in the world. We produce almost all of our more than 30,000 different items in Germany. And with more than 10,000 customers, we call every part of the world home.

---

## Your requirements set the benchmark

---

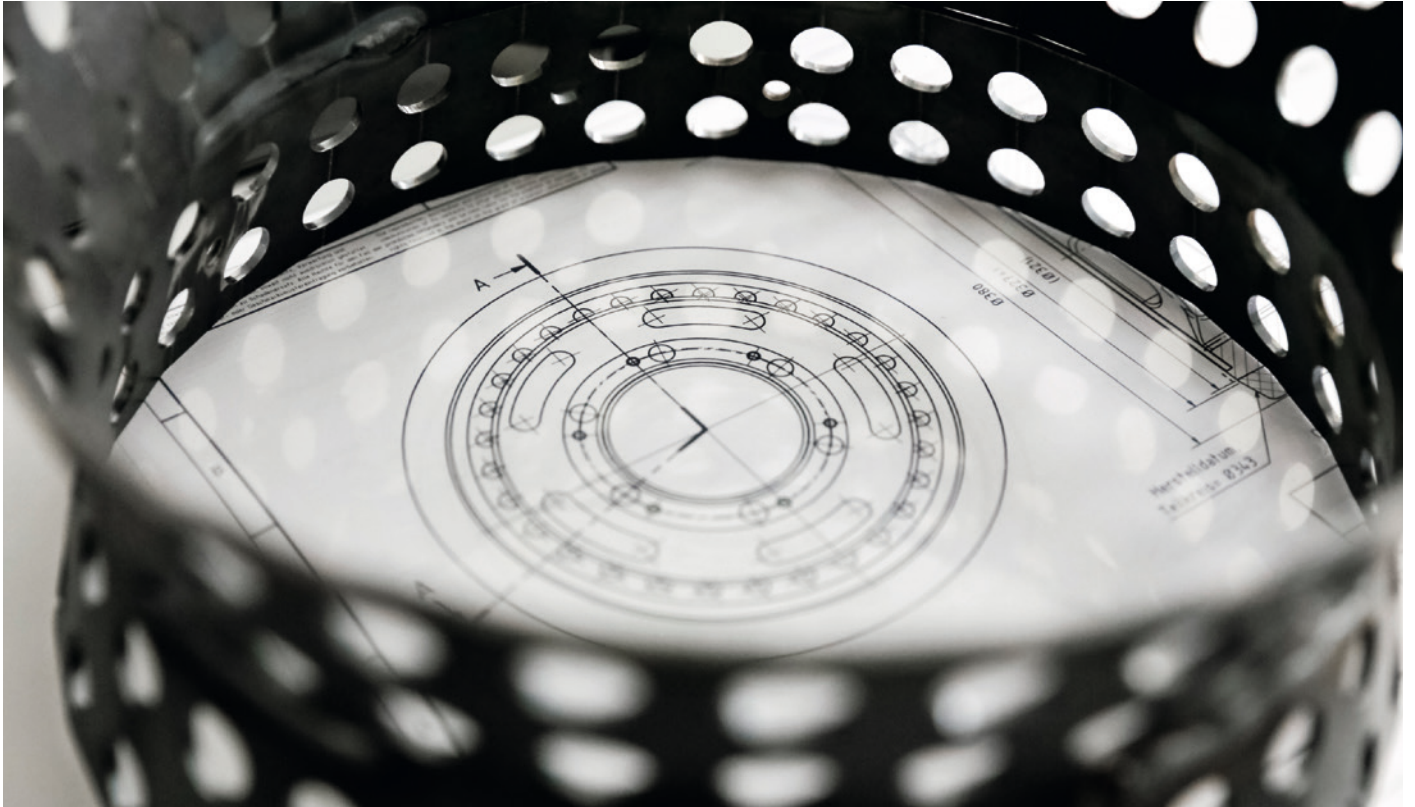

### SPECIALISTS IN CUSTOM-MADE PRODUCTS

Individual items or large batches – we are one of the market leaders in custom-made products. Forty employees in our construction and development department strive to make your wishes a reality every day. Our range of services includes the entire production development cycle – from the initial idea to construction, testing and production. Depending on the requirements and area of application, we can either adapt existing products to your needs or we can design especially tailored solutions.

### INNOVATIVE WHEEL TREAD MATERIALS

We constantly work on further developing our existing product range. This, of course, includes considering market requirements and implementing them in new products. In the development of wheel tread materials, we are the leading company in the world. We work in line with the latest scientific developments and collaborate closely with various colleges and partners. Over the past decades, we have developed and patented several materials, such as PEVODYN®, VULKOLLAN®-ELF and TRACTOTHAN®.

# The right wheel for every application

Our products drive a wide range of industries throughout the world. From the extraction and processing of raw materials to intra-logistics transport and supply systems, renowned manufacturers count on our expertise, our quality and our comprehensive product range.

From small PEVOLON® conveyor castors and heavy-duty twin-wheeled castors with PEVOF wheels to VULKOLLAN® press-on tyres – more than 30,000 items with diameters of 30 mm to 1,000 mm and load capacities of up to 80 tonnes illustrate our range of products and our expertise. From our drive, load and guiding wheels as well as our press-on tyres, running wheels and pallet castors must meet the highest standards every day. From short-term loads to continuous operation in clean rooms or in mining, our products always offer you security and reliability.



## INDUSTRY SOLUTIONS

- *Storage and system technology*
- *Automotive industry*
- *Metal production*
- *Mining*
- *Food industry*
- *Stage technology*
- *Offshore applications*
- *Amusement parks*





---

**We strive for one thing above all else:  
perfection**

---





We focus on what we do best: the production of high-quality wheels and castors. Beginning with the mechanical processing of rims and mould making, to machine casting, hand casting, injection moulding and post-processing, we manufacture almost every product here in Germany.

On an area of almost 20,000 square metres, we produce more than 30,000 wheels with over 25 different wheel tread materials every day at our three plants in Hamburg. Our state-of-the-art production facilities and automated processes form the basis for our respected high quality standards. We manufacture wheels and conveyor rollers made of PEVOLON®, PEVOTHAN® and PEVOLASTIC® using modern fully automated injection-moulding machines.

Our VULKOLLAN® and polyurethane production is the largest and most flexible of its kind in the world. This enables us to respond to your specific requirements at all times and also to produce individual items and low volumes efficiently. We also work with the most sensitive tools there are: the human hand and human eye. Although the majority of our process steps are automated, certain materials and wheel sizes can only be processed by hand casting. The many years of experience and expertise of our employees further ensure perfect results in this processing step.

As the only VULKOLLAN®-processing company, we were honoured with the Award for Excellence in Development and Implementation of Advanced VULKOLLAN® Processing Technology from Bayer MaterialScience/BaySystems for our exceptional performance.

---

# Step by step for the best result

---



## SOLID CORE

For the manufacture of our wheel centres, we process more than 8,000 tonnes of cast iron and steel from European foundries every year in our state-of-the-art mechanical production at more than 30 turning and machining centres. We purchase the wheel centres as cast exclusively from certified producers using automated moulding systems. Thanks to the high quality of the raw parts provided, we can reduce machining to a minimum and ensure a high level of concentricity.



## THE RIGHT CONNECTION

After machining, all metal cores are blasted to achieve a pure metallic surface and are then cleaned of residue in special washing machines, degreased and vacuum-dried. This is followed by a sensitive process step: application of the bonding agent. The cores are sprayed with a special bonding agent in computer-controlled systems, thus ensuring the optimal bonding between wheel centre and covering.



## A PERFECT SURFACE

Our wheel centres are heated to a predefined temperature using special fusion ovens before the actual coating takes place in order to bring the core and casting material to the same temperature and to chemically activate the bonding agent. The prepared cores are then coated with a range of different wheel tread materials, such as VULKOLLAN® or PEVOPUR®, either by machine casting or hand casting.

## THE ESSENTIAL FINAL STEP

In the manufacture of polyurethane wheel treads in hot casting, chemical reaction processes take place under strictly controlled conditions and are not terminated until long after the material has hardened. Post-treatment of the coated wheels, known as the curing process, is therefore of great importance. In our curing room, all products consequently undergo a special procedure based on predefined parameters with regard to temperature, humidity and curing duration.





---

# Quality knows no compromise

---



### CONTROL AT EVERY STEP

Your trust in our products is what drives us to get a little better every single day. This is because our wheels and castors need to withstand the test of the most extreme operating conditions when you use them. Our quality assurance system is certified according to DIN EN ISO 9001, DIN EN ISO 14001 and DIN EN ISO 3834-2, amongst others. We have also developed our own advance-warning system which is implemented in all of our processes. We monitor each step precisely and carry out 150,000 documented product and process audits every year. All of this and the extraordinary quality awareness of our employees are a further indication in our efforts to create the perfect products.

### COMPUTER-CONTROLLED TESTING

For the dynamic inspection of wheels in accordance with DIN EN 12524-12533, we have developed a special drum test rig. With speeds of up to 30 km/h and a load of up to 70 kN, we can perform endurance tests, load increase tests and driving tests including simulated steering movements and impact loads. For optimal testing of how our products respond to a wide range of challenges, we can simulate a variety of situations in test mode. The tests are of course controlled, monitored and analysed by computer.

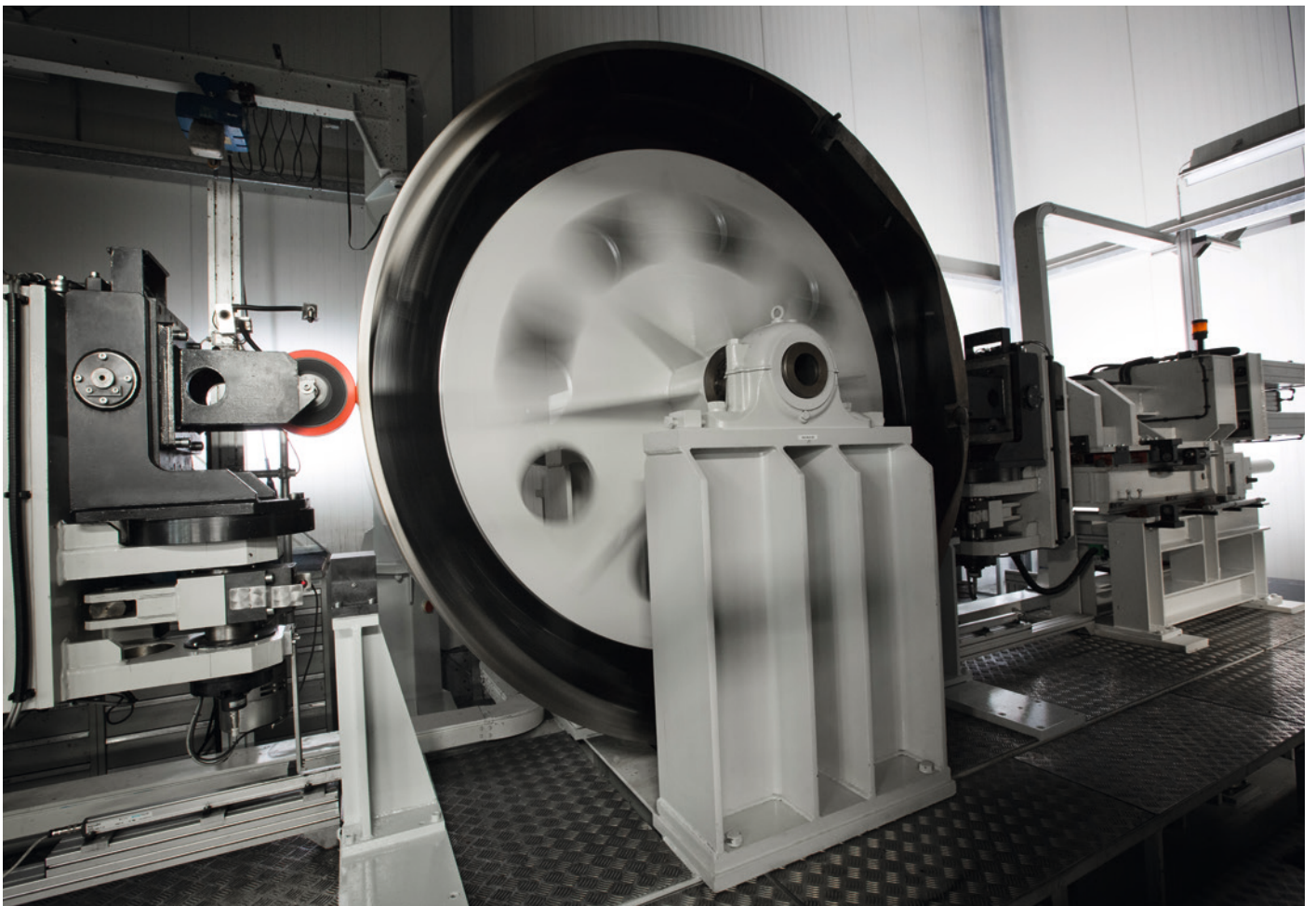

# At home in your market



## SPECIALIST CONSULTATION

As we have an extensive product portfolio and are the specialists in custom-made products, so it is second nature for us to also offer you first-class consultation service. Our internal and external sales employees are fully versed in our products and will help you to find the perfect solution, whatever your requirements. In addition to our headquarters in Hamburg, our employees are also on hand for you in four other regional branches as well as a sales office in Austria. All of our locations have their own storage facilities, so our standard products are within easy reach.



## GLOBAL SALES

You can access our wheels and castors exclusively from independent retail partners in more than 50 countries throughout the world. We have built up close and trusting relationships with many of them stretching back over decades. Our partners offer you optimal service on-site as well as high availability of our products from their own storage facilities. We also offer them regular support via intensive product training, technical consultation and collaborative customer visits. We ship our products across the whole world from Hamburg. Thanks to the excellent infrastructure connections as well as our certification as a known consignor, all goods arrive swiftly at their destinations.





























*With us, you can always count on – customer accessibility, first-class advice and personal service*





# Overview of our premium polyurethanes

	VULKOLLAN® (93° Shore A)	VULKOLLAN® hydrolysis-stabilised	PEVODYN®	PEVOPUR®	VULKOLLAN® (95° Shore A)
<b>Application</b>	<b>Standard wheel materials</b>				
Normal operating conditions	☑		☑	☑	
High speeds, long distances			☑		☑
High load capacities/demands			☑		☑
High humidity		☑	☑	☑	
Loud driving noise					
Risk of explosion					
Sensitive floors					
Wet and slippery floors					
Extremely slippery floors					
Damaged floors <ul style="list-style-type: none"> <li>• long lifespan of wheels</li> <li>• better damping</li> </ul>					☑
Cold storage <ul style="list-style-type: none"> <li>• against flat spots</li> <li>• better traction</li> </ul>					☑
<b>Hardness</b>	93° Shore A	85/93/95° Shore A	93° Shore A	93° Shore A	95° Shore A

VULKOSOFT®	VULKOLLAN®-ELF	TRACTOTHAN®	TRACTOSOFT®	VULKOLLAN®-Quarz	VULKODYN®	PEVODYN®-Sof	PEVOSOFT®
<b>Wheel materials for special requirements</b>							
							
							
							
							
							
							
							
							
						 	
							
85° Shore A	95° Shore A	93° Shore A	85° Shore A	94° Shore A	94° Shore A	78° Shore A	75° Shore A

---

## Standard wheel materials

---

All of our polyurethane elastomers are processed in a hot-casting process. In contrast to cold-cast systems, these are of a higher quality and must undergo subsequent heat treatment known as curing. They are non-marking, have low starting and rolling resistances, good resistance to mineral oils and greases as well as various solvents. Standard materials are generally produced by machine casting; we produce special tread materials and custom-made products by hand casting.



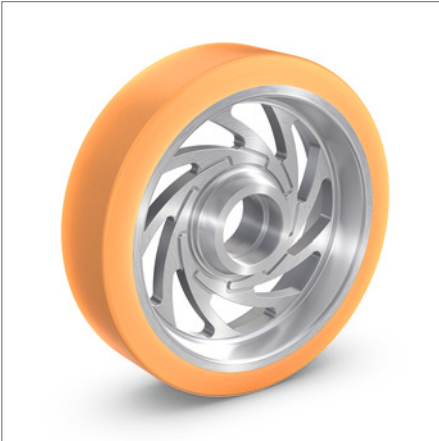

**VULKOLLAN® (93° Shore A)/HYDROLYSIS-STABILISED VULKOLLAN®**

VULKOLLAN® is a highly elastic, cross-linked polyurethane elastomer based on Desmodur® 15 with excellent mechanical properties. This includes high dynamic load capacity, high abrasion resistance and tear growth resistance, the highest modulus of elasticity of all elastomers, high mechanical wear resistance as well as high impact resilience and low compression set. As a result, VULKOLLAN® is the preferred choice for use in drive wheels and load wheels in industrial

trucks, materials handling and mechanical engineering. For applications in tropical environments, we recommend hydrolysis-stabilised VULKOLLAN®.

- Long service life
- High load capacities
- High speeds
- High impact resilience



**PEVODYN®**

PPEVODYN® is a new high-quality polyurethane elastomer which we have developed, to offer a significantly reduced starting and rolling resistance as well as high dynamic load capacity. The material is therefore particularly suitable for intra-logistic applications. Thanks to its hydrolysis resistance, PEVODYN® is perfectly suited for use in tropical climates.

- Long service life
- High load capacities
- High speeds
- High energy efficiency

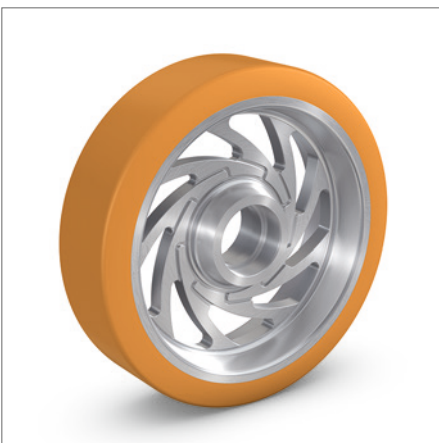

**PEVOPUR®**

PEVOPUR® is a high-quality polyurethane elastomer which offers good dynamic load capacity, high elasticity, good mechanical wear resistance and good compressive set quality. PEVOPUR® is also significantly more resilient than rubber. Consequently, the material is particularly suitable for applications with lower requirements and is ideally suited for use in tropical climates.

- Medium load capacities
- Medium speeds

# Wheel materials for special requirements

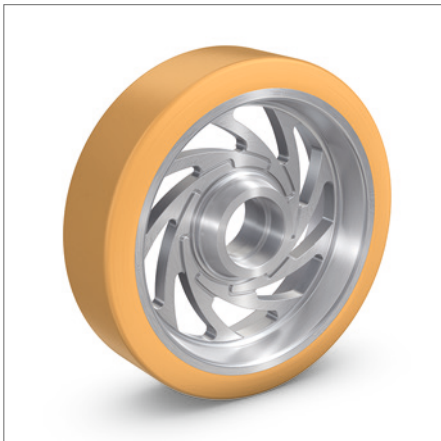

## VULKOLLAN® (95° Shore A)

VULKOLLAN® 95° Shore A is a highly elastic polyurethane elastomer based on Desmodur® 15 for demanding and dynamic areas of application. The excellent mechanical properties of the material include very high dynamic load capacity, very high abrasion resistance and tear growth resistance, very high mechanical wear resistance and very low compression set. We recommend

VULKOLLAN® 95° Shore A for use in the transport of very heavy loads and at high speeds.

- Long service life
- Very high load capacities
- Very high speeds
- Minimal flat spots

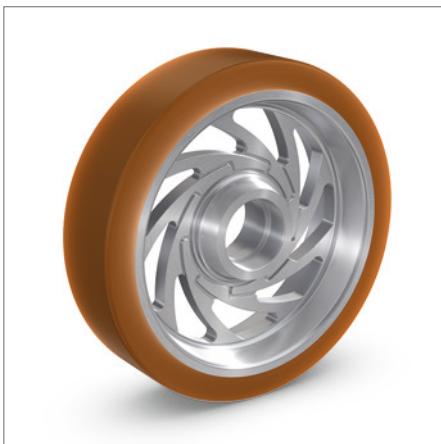

## VULKOSOFT®

VULKOSOFT® is a highly elastic polyurethane elastomer based on Desmodur® 15. Like all VULKOLLAN® versions, the material has excellent mechanical properties including good dynamic load capacity, good abrasion resistance and tear growth resistance, high impact resilience and low compression set. With a Shore hardness of 85° Shore A, VULKOSOFT® combines high load capacity with good noise reduction and vibration damping and is therefore particularly suitable for

use on surfaces where care is needed, for example on tile floors.

- Medium load capacities
- Medium speeds
- Good noise reduction and vibration damping
- Floor preserving



## VULKOLLAN®-ELF

VULKOLLAN®-ELF is our patented special material based on Desmodur® 15 for deflecting electrostatic charges. Through the addition of electrically conductive components, the discharge is carried out through the entire tread and over the entire contact area, regardless of the wear on the tread. VULKOLLAN®-ELF comfortably exceeds the requirements set by the DIN EN 12527 ff standard for electrical volume resistance and is particularly suitable for use in operations where there is risk of

fire or explosion, in areas with highly densified, charged air or with extremely concentrated dust particles.

- Prevents electrostatic charges
- Medium load capacities

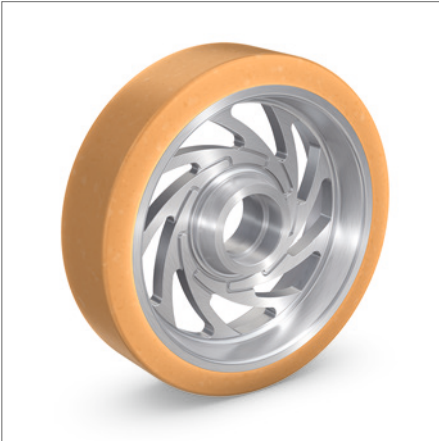

**TRACTOTHAN®**

TRACTOTHAN® is a VULKOLLAN® composite material developed and patented by us with the same properties as VULKOLLAN®. Special TPU granules incorporated into the tread ensure increased wheel grip, thus improving starting properties, preventing slip and improving braking effects. TRACTOTHAN® is therefore particularly suitable for in-plant transportation and use on wet and soiled surfaces.

- Increased braking effect
- Reduced risk of sliding
- High load capacities
- High speeds

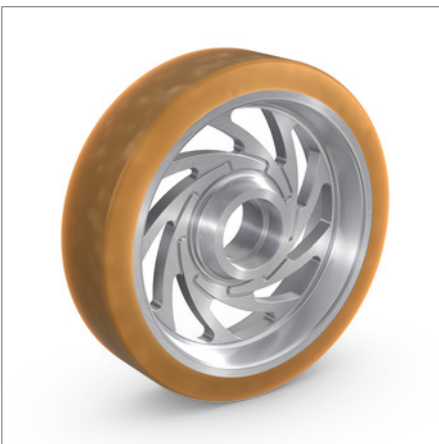

**TRACTOSOFT®**

TRACTOSOFT® is a VULKOLLAN® composite material developed and patented by us with the same properties as VULKOLLAN®. Special TPU granules incorporated into the tread ensure increased wheel grip, thus improving starting properties, preventing slip and improving braking effects. Thanks to the lower Shore hardness of 85° Shore A, TRACTOSOFT® is particularly suited for use in transportation on wet and soiled surfaces where noise reduction and protection of the

products being transported are also important factors.

- Reduced risk of sliding
- Medium load capacities
- Medium speeds
- Floor preserving



**VULKOLLAN®-QUARZ**

VULKOLLAN®-Quartz is a VULKOLLAN® composite material which we have developed for use on extremely wet, slippery and greasy surfaces. With the addition of quartz sand, the material has significantly better traction, while the excellent properties of VULKOLLAN® are preserved as much as possible. VULKOLLAN®-Quartz is therefore particularly suited to the most extreme types of usage in the fish and meat industries or in creameries, although it does have an abrasive effect due to its

structure, which can damage the coating on industrial floors.

- Very high braking effect
- Very low risk of sliding
- Medium load capacities
- Medium speeds

# Wheel materials for special requirements



## VULKODYN®

VULKODYN® is a highly elastic polyurethane elastomer which we have developed for extremely dynamic applications. The material has excellent properties such as approximately 20% lower rolling resistance, higher load capacity at the same speeds, better driving comfort thanks to good damping, lower risk of flat spots during stoppages, hydrolysis resistance and better traction. VULKODYN® is therefore particularly suited for use at high speeds.

- Long service life
- Very high load capacities
- Extreme speeds
- Minimal rolling resistance



## PEVODYN®-Soft

PEVODYN®-Soft 78° Shore A is a new high-quality polyurethane elastomer that we have developed with high dynamic load capacity and significantly reduced starting and rolling resistance. The excellent mechanical properties of the material include high cutting, tearing and abrasion resistance. Thanks to its good noise reduction and vibration damping, PEVODYN®-Soft is particularly suitable for use on surfaces where care is needed. And with its hydrolysis resistance, the

material is ideally suited for use in tropical climates.

- Medium load capacities
- High speeds
- High energy efficiency
- Good noise reduction and vibration damping
- Floor preserving

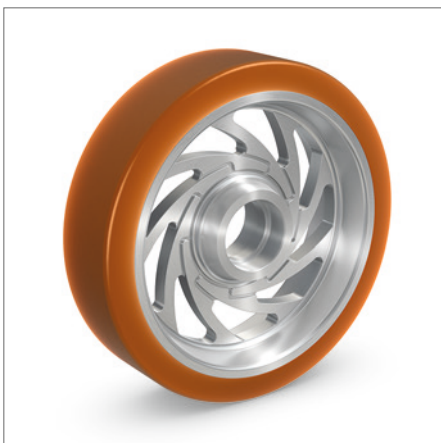

## PEVOSOFT®

PEVOSOFT® is a high-quality polyurethane elastomer which offers good dynamic load capacity, high elasticity, good mechanical wear resistance and good compressive set quality. PEVOSOFT® is also significantly more resilient than rubber. With a Shore hardness of 75° Shore A, it is suitable for all areas of application where better noise reduction and vibration damping, floor-preserving usage, high driving comfort or secure transportation of delicate goods are required.

- Lower load capacities
- Lower speeds
- Floor preserving

---

# Wheel materials for industrial and heavy duty castors

---

Our industrial castors are used in industry for in-plant transportation in indoor and outdoor areas. They are specially designed for transportation speeds of up to 4 km/h and have a load capacity of up to 50 t. Thanks to their resistance to various environmental effects, they are used for machines and devices of all kinds, as well as for work platforms, transport trolleys, assembly trolleys, storage trolleys and container wagons.



## PEVOLON®

PEVOLON® is a thermoplastic material based on polyamide which is non-marking, has good chemical resistance, high abrasion resistance, low rolling resistance and a high loading capacity of up to 2 t. The material also has high cold and heat resistance (-40°C to +90°C), while the loading capacity is reduced in temperatures of more than 35°C. PEVOLON® is suitable for use in areas including freezer rooms, wet rooms and cooking rooms, as well as smokehouses.

- Food industry
- Chemicals industry
- Environmental industry

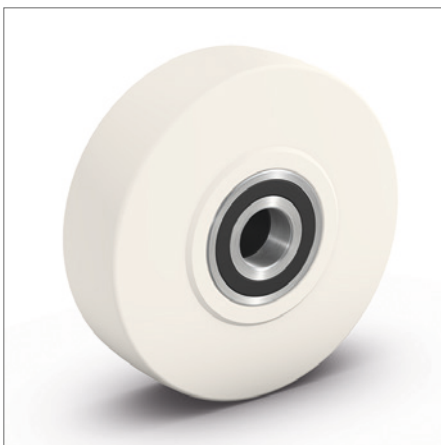

## PAG

Cast polyamide (PAG) has primarily the same excellent physical properties as PEVOLON® and has an extremely high loading capacity (up to 50 t), good chemical resistance, high elasticity, good abrasion resistance, easy processability, low moisture absorption and long service life. The material also has high cold and heat resistance (-40°C to +90°C), while the loading capacity is reduced in temperatures of more than 35°C.

- Materials handling
- Automotive industry
- Environmental industry



# Wheel materials for industrial and heavy duty castors

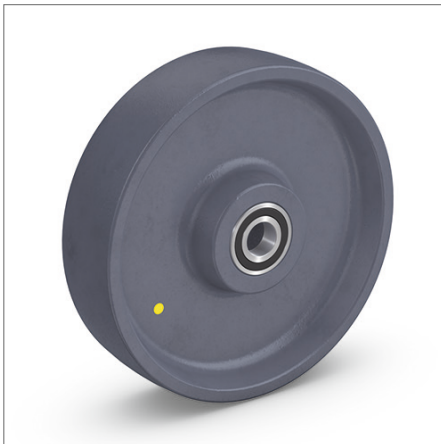

## PEVOLON®-ELF

PEVOLON®-ELF is a specially processed thermoplastic material for deflecting electrostatic charges and has the same physical properties as PEVOLON®. In contrast to other electrically conductive polyamides and rubber, this is non-marking. The electrical deflection with PEVOLON®-ELF is carried out over the entire wheel or over the entire contact area, where the requirements set by the DIN EN 12527 ff standard for electrical volume resistance are comfortably exceeded.

- Operations with a risk of explosion
- Chemicals industry
- Pharmaceutical industry
- Coatings and paint industry
- Pyrotechnics industry

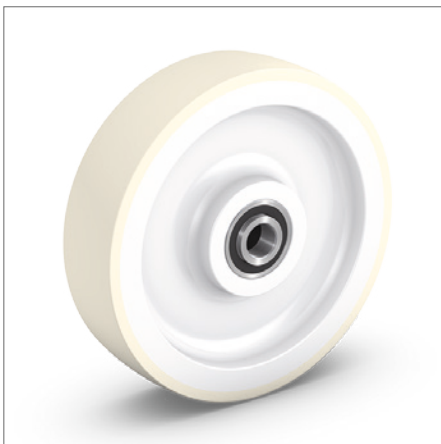

## PEVOLASTIC®

PEVOLASTIC® wheels consist of a PEVOLON® rim with a mechanically non-detachable fixed tread face made of thermoplastic polyurethane. The excellent product attributes include non-marking properties, high abrasion resistance, resistance to diluted acids and alkalis as well as mineral greases and oils, and a high loading capacity of up to 1,100 kg. These wheels have a temperature resistance of between -20°C and +80°C.

- Chemicals industry
- Food industry
- Environmental technology and wastewater treatment

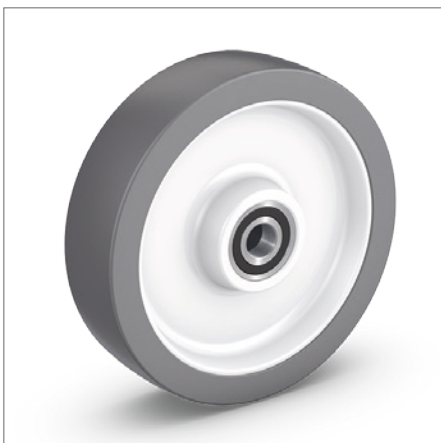

## PEVOTHAN®

PEVOTHAN® is a high-quality processed thermoplastic polyurethane elastomer with excellent properties, such as non-marking characteristics, high abrasion resistance, good damping power, loading capacities of up to 500 kg and temperature resistance of between -20°C and +80°C. PEVOTHAN® is also widely resistant to diluted acids and alkalis as well as mineral greases and oils. Thanks to these properties, PEVOTHAN® is superior to all

normal rubber wheels and is particularly recommended for sensitive surfaces.

- Sensitive surfaces
- Chemicals industry
- Food industry
- Environmental industry

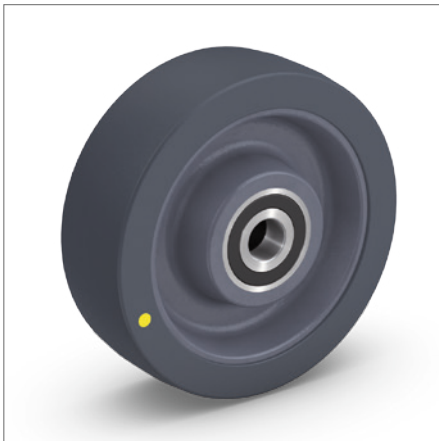

### PEVOTHAN®-ELF

PEVOTHAN®-ELF is a specially processed thermoplastic material for deflecting electrostatic charges. The electrical deflection is carried out over the entire tread, where the requirements set by the DIN EN 12527 ff standard for electrical volume resistance are comfortably exceeded. PEVOTHAN®-ELF wheels are also non-marking and, thanks to the physical properties of PEVOTHAN®, are particularly recommended in operations with

a risk of explosion and with sensitive surfaces.

- Operations with a risk of explosion and with sensitive surfaces
- Chemicals industry
- Pharmaceutical industry
- Coatings and paint industry
- Pyrotechnics industry



### RUBBER

In comparison with polyamides and polyurethane, rubber has a higher rolling resistance and is particularly floor preserving. Thanks to the variety of attributes and wheel body materials, rubber wheels can be used for a wide range of applications in in-plant transportation. We can offer you solid rubber and ELASTIC solid rubber wheels, thermoplastic rubber wheels and wheels with SUPER-ELASTIC tyres and pneumatic tyres.

- Materials handling and transport technology
- Environmental industry

---

## Wheels for industrial trucks

---

We have been the global OEM development partner for all leading manufacturers of industrial trucks for more than 20 years. We offer our customers an extensive product portfolio for after-sales management and for resolving intra-logistic challenges. We develop our products based on the design-to-cost principle, where all steps are subject to a continuous improvement process. We provide pre-assembled components and parts, according to the just-in-time concept if required, or integrated in the customer's Kanban system.



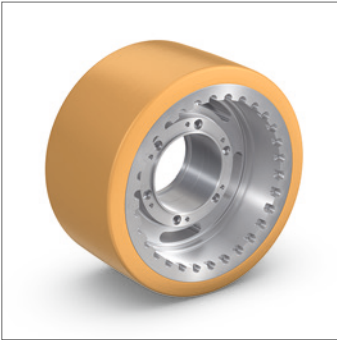

**Load wheel**  
 • VULKOLLAN®  
 • 380 x 192 mm

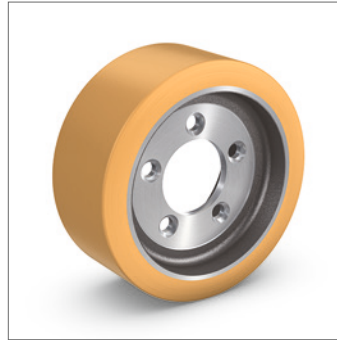

**Drive wheel**  
 • VULKOLLAN®  
 • 250 x 105 mm

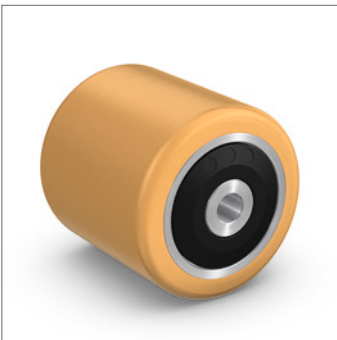

**Pallet roller**  
 • VULKOLLAN®  
 • 85 x 85 mm



**Load wheel**  
 • VULKOLLAN®  
 • 285 x 100 mm

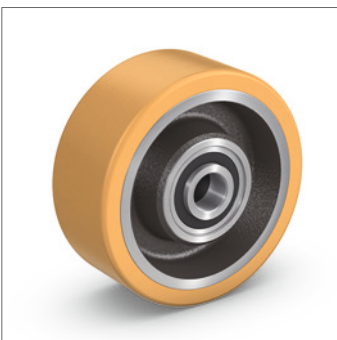

**Stabilising wheel**  
 • VULKOLLAN®  
 • 125 x 50 mm

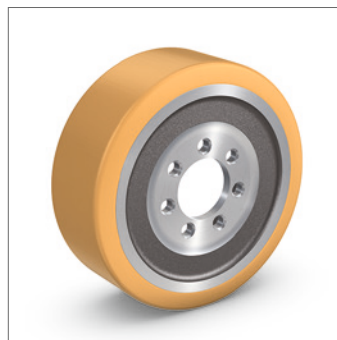

**Drive wheel**  
 • VULKOLLAN®  
 • 360 x 130 mm

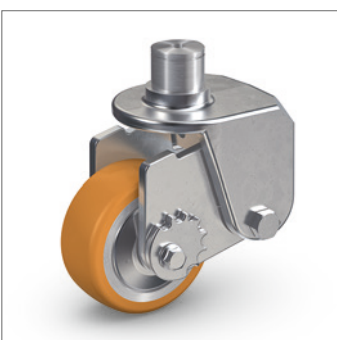

**Stabilising castor**  
 • PEVOPUR®  
 • 100 x 40 mm

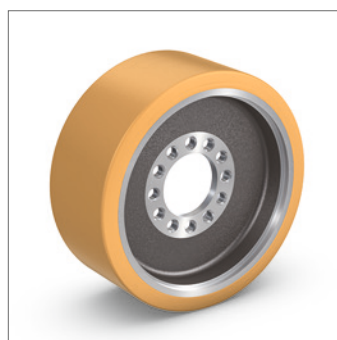

**Drive wheel**  
 • VULKOLLAN®  
 • 406 x 170 mm

---

## Custom-made products

---

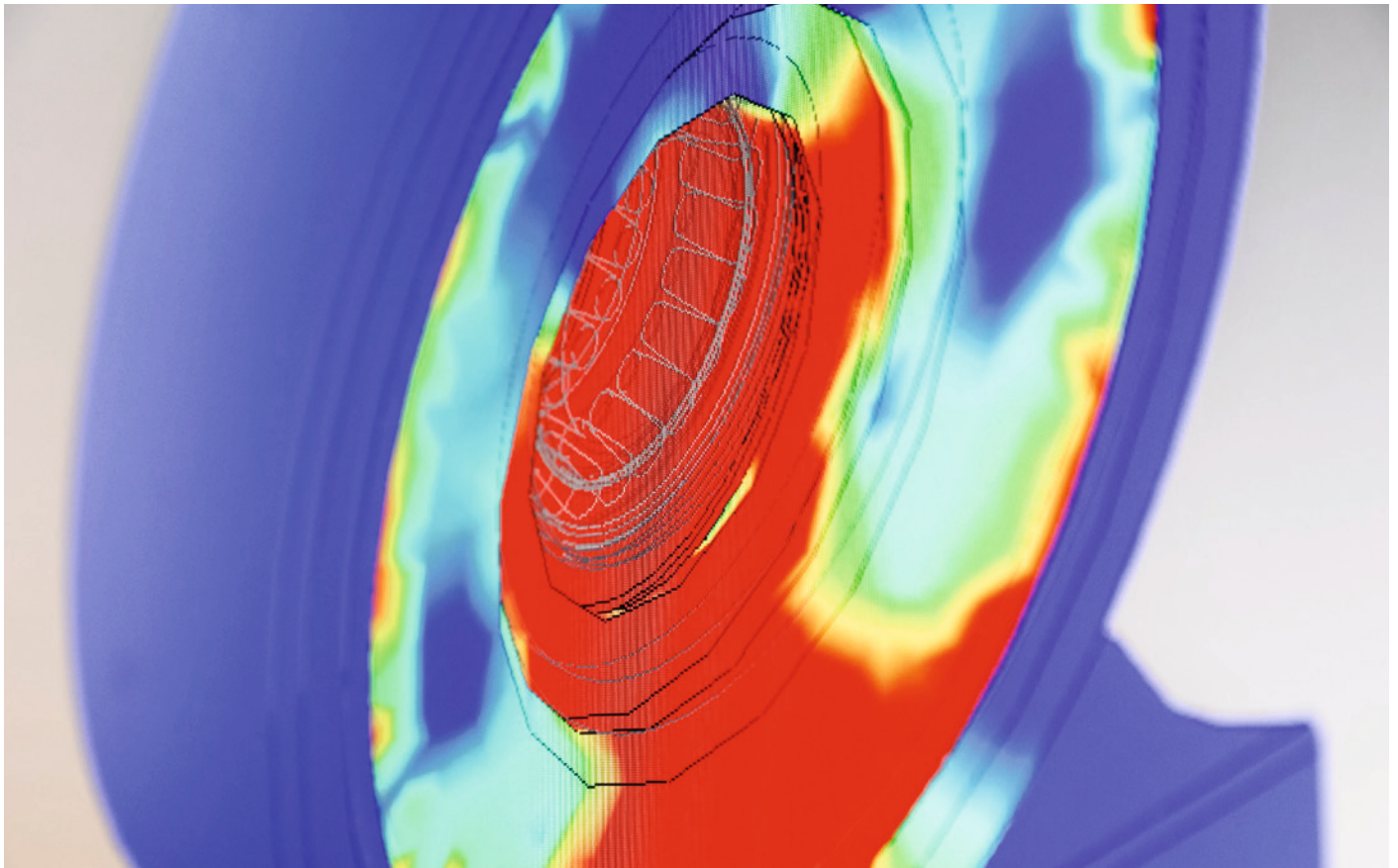

We see it as our duty to be able to respond to your requirements for special wheels and castors. We welcome every challenge, as your individual needs are paramount to us. In cooperation with you, we develop solutions for complex challenges. With our years of experience and extensive expertise, we construct top-quality wheels and castors. The latest tools, such as 3D CAD systems, FEM calculations and simulations, are some of the essentials in the development process. Our specialist consultants will guide you from the beginning of a project right through to its successful conclusion. Your satisfaction is our primary goal, as this is the only way to forge long-term, precious partnerships which we value greatly.

### PEVOTEC®

Behind the name PEVOTEC® is an extensive range of special polyurethane elastomers which are used under extreme operating conditions. Depending on the task at hand, we develop the ideal wheel material for you by adapting the chemical and physical properties of the materials to suit your requirements.



### RELIABILITY BELOW GROUND

Below ground, conditions are extreme. In the transportation of people and materials by mine rail, containing mineral salts, places exceptional demands on our products. Thanks to their excellent material properties, we only use wheels from our high-performance VULKOLLAN® 95° Shore A range for this purpose. The material can withstand the heaviest loads and has a high static friction value, enabling it to handle inclines and declines of up to 30 degrees. Our customers have already testified to its long service life on many occasions.

---

## Custom-made products

---



### FLEXIBLE EVEN WITH HEAVY LOADS

Our PEVOTEC® wheels are used in manipulators for workpiece transportation between heat furnaces and forging units. The material used is designed for the special requirements of heavy-duty applications and can also handle extreme stress and temperature requirements. The wheels also provide the unit with a high level of flexibility and freedom of movement, even where mounting space is tight.

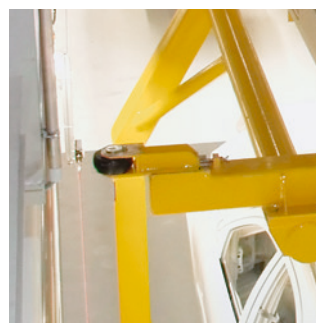
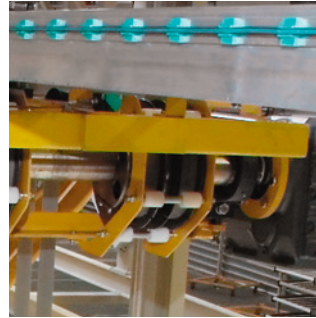

### DISRUPTION-FREE IN CONTINUOUS OPERATION

Electrified overhead conveyors are used in the automobile industry as well as by beverage manufacturers and large flower markets, for example, for in-plant transportation of materials and goods. VULKOLLAN® wheels ensure continuous and disruption-free operation of rail-guided, self-propelled, overhead conveyor systems. The material has a high dynamic load capacity, high wear resistance and is also extremely elastic.



# PE·VO·LON® wheels

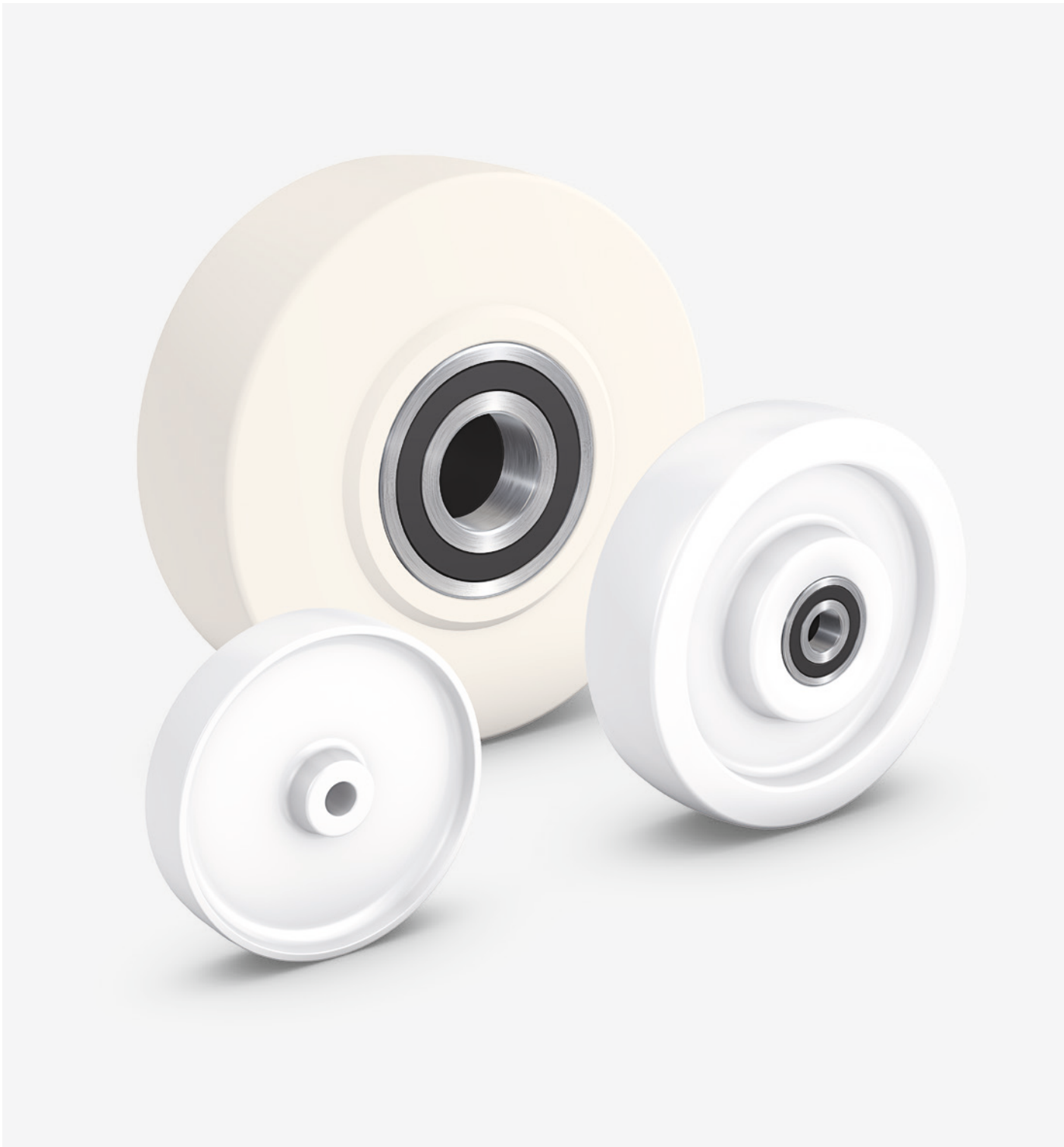

PEVOLON® • PEVOLASTIC®  
PEVOTHA®

Solid rubber  
wheels and castors

Electrically conductive  
wheels and castors

VULKOLLAN® • PEVOPUR®  
PEVODYN® / -Soft

Stainless steel castors

Institutional  
wheels and castors

Conveyor/guiding  
rollers and ball units

Profile rollers

Pallet rollers

Press-on tyres

# PE·VO·LON® product overview

## PEVOLON® WHEELS AND CASTORS

PEVOLON® is a thermoplastic material based on polyamide. PEVOLON® wheels have high abrasion resistance, a low friction coefficient, high load capacities and a long lifespan.

The precise workmanship guarantees the functionality of swivel and fixed castor housings. Compact brake systems offer long-lasting, secure locking for all areas of application. The dimensions fulfil to the standards of the European manufacturers of castors.



Series A  
70 - 2.000 kg  
Page 36 - 37



Series PAG  
1.000 - 50.000 kg  
Page 38



Series B  
150 - 1.000 kg  
Page 39



Series 86 HH  
100 - 125 kg  
Page 39



Series PL/PB  
75 - 400 kg  
Page 41 - 42



Series WL/WB  
300 - 1.400 kg  
Page 43



Series TL/TB  
600 - 1.000 kg  
Page 44



Series ULC/UBC  
700 - 2.000 kg  
Page 45



Series ULCD/UBCD  
1.100 - 20.000 kg  
Page 46



Series UL PAG  
Series UB PAG  
1.750 - 12.000 kg  
Page 47



Series A/1

Article code	mm	mm	mm	mm	mm	kg
A 040/033/1/10	40	33	35	17	10	80
A 045/019/1/10	45	19	22	16	10	70
A 050/017/1/10-1	50	17	20	26	10	150
A 050/017/1/10-2	50	17	19	20	10	140
A 050/019/1/06	50	19	27	13	06	100
A 050/025/1/10	50	25	30	18	10	150
A 060/020/1/10	60	20	25	20	10	150
A 065/030/1/10	65	30	35	20	10	170
A 070/030/1/10	70	30	40	25	10	200
A 075/023/1/15	75	23	25	30	15	200
A 080/035/1/15	80	35	37	30	15	300
A 080/035/1/20	80	35	35	50	20	300
A 100/030/1/10	100	30	40	35	10	300
A 100/040/1/15	100	40	50	48	15	450
A 100/050/1/15	100	50	60	55	15	600
A 125/040/1/15	125	40	53	60	15	600
A 125/050/1/15	125	50	60	56	15	700
A 125/050/1/20	125	50	60	56	20	700
A 150/040/1/15	150	40	50	35	15	450
A 150/040/1/20	150	40	53	65	20	700
A 150/050/1/20-1	150	50	55	65	20	600
A 150/050/1/20-2	150	50	60	62	20	800
A 160/050/1/20	160	50	60	63	20	850
A 175/040/1/20	175	40	57	65	20	800
A 175/050/1/20	175	50	55	65	20	750
A 200/040/1/15	200	40	50	45	15	750
A 200/040/1/20	200	40	58	65	20	1.000
A 200/050/1/20-1	200	50	55	65	20	1.000
A 200/050/1/20-2	200	50	60	65	20	1.200
A 200/050/1/25	200	50	60	65	25	1.200
A 250/050/1/20	250	50	60	65	20	1.500
A 250/050/1/25	250	50	60	65	25	1.500
A 250/060/1/25	250	60	65	90	25	1.500
A 300/060/1/30	300	60	70	92	30	2.000

## PEVOLON® wheels with plain bearing

High-quality thermoplastic polyamide. Wheels in heavy-duty design with maintenance-free plain bearing (/1).

PEVOLON® - PEVOLASTIC®  
PEVOTHA®

Solid rubber  
wheels and castors

Electrically conductive  
wheels and castors

VULKOLAN® - PEVOPUR®  
PEVODYN® / -Soft

Stainless steel castors

Institutional  
wheels and castors

Conveyor/guiding  
rollers and ball units

Profile rollers

Pallet rollers

Press-on tyres



Series A/5

Article code	mm	mm	mm	mm	mm	mm	kg
A 080/035/5/12	80	35	35	33	50	12	300
A 100/040/5/12	100	40	50	43	48	12	450
A 100/040/5/17	100	40	50	50	48	17	450
A 100/050/5/20	100	50	60	60	55	20	600
A 120/050/5/20	120	50	58	56	58	20	600
A 125/040/5/20	125	40	53	53	60	20	600
A 125/050/5/20	125	50	60	62	70	20	700
A 150/040/5/20	150	40	53	51	65	20	700
A 150/050/5/12	150	50	55	60	65	15	600
A 150/050/5/20-1	150	50	55	53	65	20	600
A 150/050/5/20-2	150	50	60	62	76	20	800
A 160/040/5/20	160	40	60	58	60	20	600
A 175/050/5/20	175	50	55	53	65	20	800
A 200/050/5/12	200	50	55	60	65	15	1.000
A 200/050/5/20	200	50	60	60	85	20	1.200
A 200/065/5/25	200	65	74	72	80	25	1.300
A 250/050/5/25	250	50	60	60	92	25	1.500
A 250/060/5/25	250	60	65	63	90	25	1.500
A 300/060/5/25	300	60	70	68	92	25	2.000

## PEVOLON® wheels with ball bearings

High-quality thermoplastic polyamide. Wheels in heavy-duty design with ball bearings (/5).

PEVOLON® • PEVOLASTIC®  
PEVOTHA®

Solid rubber  
wheels and castors

Electrically conductive  
wheels and castors

VULVOLAN® • PEVOPUR®  
PEVODYN® / -Soft

Stainless steel castors

Institutional  
wheels and castors

Conveyor/guiding  
rollers and ball units

Profile rollers





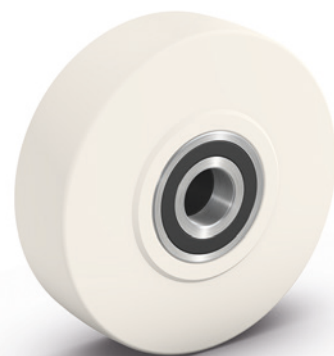

Pallet rollers

Press-on tyres

# PE·VO·LON® heavy-duty wheels



Series PAG

Article code	 mm	 mm	 mm	 mm	 mm	 mm	 kg
PAG 080/040/5/20 B	80	40	45	45	65	20	1.000
PAG 100/040/5/20 B	100	40	45	45	65	20	1.250
PAG 125/055/5/25 B	125	55	60	60	80	25	2.000
PAG 150/055/5/30 B	150	55	60	60	95	30	2.500
PAG 150/080/5/35 B	150	80	90	90	100	35	3.000
PAG 200/055/5/35 B	200	55	60	60	100	35	3.000
PAG 200/080/5/45 B	200	80	90	90	120	45	4.500
PAG 250/065/5/45 B	250	65	70	70	120	45	5.000
PAG 250/080/5/50 B	250	80	90	90	130	50	6.000
PAG 300/080/5/55 B	300	80	90	90	150	55	7.000
PAG 300/110/5/70 B	300	110	120	120	180	70	10.000
PAG 400/110/5/80 B	400	110	120	120	210	80	12.000
PAG 500/130/5/100 B	500	130	130	130	-	100	15.000
PAG 600/150/3/100 B	600	150	165	170	300	100	21.000
PAG 700/200/3/130 B	700	200	215	220	300	130	30.000
PAG 1000/330/3/160 B	1000	330	345	350	400	160	50.000

## PEVOLON® heavy-duty wheels

High-quality thermoplastic polyamide. Wheels in extra heavy-duty design made of hard and tough, highly compressed cast polyamide with ball bearings (/5) or spherical roller bearings (/3).

PEVOLON® - PEVOLASTIC®  
PEVOTHA®

Solid rubber  
wheels and castors

Electrically conductive  
wheels and castors

VULVOLAN® - PEVOPUR®  
PEVODIN® - Soft

Stainless steel castors

Institutional  
wheels and castors

Conveyor/guiding  
rollers and ball units

Profile rollers

Pallet rollers







Press-on tyres

# PE·VO·LON® wheels heat-resistant wheels









Series 86 HH

Series B

 Article code	 mm	 mm	 mm	 mm	 mm	 kg
B 080/030/1/10	80	30	35	18	10	150
B 080/035/1/12	80	35	40	20	12	150
B 100/034/1/10	100	34	40	25	10	200
B 100/034/1/12	100	34	40	25	12	200
B 108/035/1/10	108	35	40	25	10	200
B 125/040/1/15	125	40	50	30	15	300
B 150/042/1/15	150	42	50	40	15	600
B 150/042/1/20	150	42	50	38	20	400
B 160/040/1/15	160	40	50	30	15	400
B 175/050/1/15	175	50	55	35	15	425
B 175/050/1/20	175	50	60	45	20	425
B 200/040/1/15	200	40	50	45	15	800
B 200/040/1/20	200	40	50	45	20	450
B 200/050/1/15	200	50	55	35	15	450
B 200/050/1/20	200	50	60	50	20	500
B 250/050/1/20	250	50	60	50	20	1.000

## PEVOLON® wheels

High-quality thermoplastic polyamide. Wheels in light-duty design with maintenance-free plain bearing (/1).

 Article code	 mm	 mm	 mm	 mm	 mm	 kg
86 HH 070/035/1/12	70	35	40	30	12	100
86 HH 080/035/1/10	80	35	40	30	10	100
86 HH 100/035/1/10	100	35	40	35	10	125
86 HH 100/035/1/10	100	35	37	35	10	125

## Heat-resistant wheels

Wheels made of phenolic resin with plain bearing (/1). Temperature-resistant from -40° C up to +230° C.

Swivel- and fixed castors with wheels series 86 HH and heat-resistant solid rubber wheels available on request.

PEVOLON® • PEVOLASTIC®  
PEVOTHA®  
Solid rubber wheels and castors  
Electrically conductive wheels and castors  
VULKOLAN® • PEVOPUR® PEVDYN® / -Soft  
Stainless steel castors  
Institutional wheels and castors  
Conveyor/guiding rollers and ball units  
Profile rollers  
Pallet rollers  
Press-on tyres

# PE·VO·LON® castors



PEVOLON® • PEVOLASTIC®  
PEVOTHA®

Solid rubber  
wheels and castors

Electrically conductive  
wheels and castors

VULKOLLAN® • PEVOPUR®  
PEVODYN® / -Soft

Stainless steel castors

Institutional  
wheels and castors

Conveyor/guiding  
rollers and ball units

Profile rollers

Pallet rollers









Press-on tyres

# PE·VO·LON® industrial castors











Series PB/1

Series PL/1

								
Article code	mm	mm	mm	mm	mm	mm	mm	kg
PL 050/25/1	50	25	72	80 x 60	60 x 40	7	21	75
PL 070/30/1 L	70	30	103	105 x 85	80 x 60	9	38	120
PL 080/30/1 L	80	30	108	105 x 85	80 x 60	9	38	120
PL 100/34/1 L	100	34	128	105 x 85	80 x 60	9	38	125
PL 100/40/1	100	40	126	135 x 110	105 x 80	11	40	300
PL 125/40/1 L	125	40	155	105 x 85	80 x 60	9	45	180
PL 125/40/1	125	40	164	135 x 110	105 x 80	11	55	300
PL 150/42/1	150	42	194	135 x 110	105 x 80	11	55	300
PL 175/50/1	175	50	217	135 x 110	105 x 80	11	55	350
PL 200/50/1	200	50	239	135 x 110	105 x 80	11	55	400
PL 250/50/1	250	50	290	135 x 110	105 x 80	11	55	400

## Industrial swivel castors with PEVOLON® wheels

Wheels series A/B with plain bearing (/1), see page 36/39.

							
Article code	mm	mm	mm	mm	mm	mm	kg
PB 050/25/1	50	25	72	93 x 50	71 x 24	6	75
PB 070/30/1 L	70	30	103	105 x 85	80 x 60	9	120
PB 080/30/1 L	80	30	108	105 x 85	80 x 60	9	120
PB 100/34/1 L	100	34	128	105 x 85	80 x 60	9	125
PB 100/40/1	100	40	126	135 x 110	105 x 80	11	300
PB 125/40/1	125	40	164	135 x 110	105 x 80	11	300
PB 125/40/1 L	125	40	155	105 x 85	80 x 60	9	180
PB 150/42/1	150	42	194	135 x 110	105 x 80	11	300
PB 175/50/1	175	50	217	135 x 110	105 x 80	11	350
PB 200/50/1	200	50	239	135 x 110	105 x 80	11	400
PB 250/50/1	250	50	290	135 x 110	105 x 80	11	400

## Industrial fixed castors

1-way directional lock only available for plate 135 x 110 mm.  
ALLSTOP total locking device not available for wheel diameter 50 mm and 70 mm.

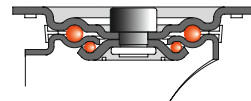

## Industrial swivel castor brackets with a load capacity of up to 400 kg

Housings made of pressed steel, zinc and chromated. Swivel head with double ball bearings, dust and splash proof, with riveted kingpin. ALLSTOP total locking device on the trailing side of the housing, blocks rolling and swivel motion simultaneously.

\* with locking device code: PLFZ...

ALLSTOP total locking device  
Code: PLF...

single bolt hole  
Code: PL...R

single bolt hole/total lock  
Code: PLF...R



directional lock  
Code: PL.../...TRIF

foot protection  
Code: ...PRO

stem fitting  
Code: PLZ...\*





# PE·VO·LON® industrial castors



Series PB/3

Series PL/3

Article code	mm	mm	mm	mm	mm	mm	mm	kg
PL 100/34/3 L	100	34	128	105 x 85	80 x 60	9	38	125
PL 125/40/3 L	125	40	155	105 x 85	80 x 60	9	45	150
PL 125/40/3	125	40	164	135 x 110	105 x 80	11	55	250
PL 150/42/3	150	42	194	135 x 110	105 x 80	11	55	300
PL 200/50/3	200	50	239	135 x 110	105 x 80	11	55	400
PL 100/40/5	100	40	126	135 x 110	105 x 80	11	40	300
PL 125/40/5	125	40	164	135 x 110	105 x 80	11	55	300
PL 150/50/5	150	50	194	135 x 110	105 x 80	11	55	400
PL 200/50/5	200	50	239	135 x 110	105 x 80	11	55	400
PL 250/50/5	250	50	290	135 x 110	105 x 80	11	55	400

## Industrial swivel castors with PEVOLON® wheels

Wheels series A/B with roller bearing (/3) or ball bearings (/5). Wheels series A with ball bearings (/5), see page 37.

Article code	mm	mm	mm	mm	mm	mm	kg
PB 100/34/3 L	100	34	128	105 x 85	80 x 60	9	125
PB 125/40/3 L	125	40	155	105 x 85	80 x 60	9	150
PB 125/40/3	125	40	164	135 x 110	105 x 80	11	250
PB 150/42/3	150	42	194	135 x 110	105 x 80	11	300
PB 200/50/3	200	50	239	135 x 110	105 x 80	11	400
PB 100/40/5	100	40	126	135 x 110	105 x 80	11	300
PB 125/40/5	125	40	164	135 x 110	105 x 80	11	300
PB 150/50/5	150	50	194	135 x 110	105 x 80	11	400
PB 200/50/5	200	50	239	135 x 110	105 x 80	11	400
PB 250/50/5	250	50	290	135 x 110	105 x 80	11	400

## Industrial fixed castors

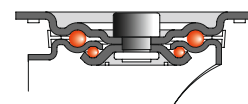

## Industrial swivel castor brackets with a load capacity of up to 400 kg

Housings made of pressed steel, zinc and chromated. Swivel head with double ball bearings, dust and splash proof, with riveted kingpin. Standard type with top plate. ALLSTOP total locking device on the trailing side of the housing, blocks rolling and swivel motion simultaneously.

\* with locking device code: PLFZ...

ALLSTOP total locking device  
Code: PLF...



single bolt hole  
Code: PL.../...R



single bolt hole/total lock  
Code: PLF.../...R



directional lock  
Code: PL.../...TRIF



foot protection  
Code: ...PRO



stem fitting  
Code: PLZ...\*



# PE·VO·LON®

## heavy-duty industrial castors



Series WB/5

Series WL/5

Article code	mm	mm	mm	mm	mm	mm	mm	kg
WL 080/35/5 L	80	35	118	105 x 85	80 x 60	9	40	300
WL 100/40/5 L	100	40	140	105 x 85	80 x 60	9	45	350
WL 100/50/5	100	50	148	135 x 110	105 x 80	11	50	600
WL 125/40/5 L	125	40	165	105 x 85	80 x 60	9	45	350
WL 125/50/5	125	50	178	135 x 110	105 x 80	11	50	700
WL 150/50/5	150	50	205	135 x 110	105 x 80	11	50	750
WL 175/50/5	175	50	228	135 x 110	105 x 80	11	50	750
WL 200/50/5	200	50	250	135 x 110	105 x 80	11	55	750
WL 250/50/5	250	50	307	200 x 160	160 x 120	15	63	1.000
WL 300/60/5	300	60	347	200 x 160	160 x 120	15	73	1.400

### Heavy-duty industrial swivel castors with PEVOLON® wheels

Wheels series A with ball bearings (/5), see page 37.

Article code	mm	mm	mm	mm	mm	mm	kg
WB 080/35/5 L	80	35	118	105 x 85	80 x 60	9	300
WB 100/40/5 L	100	40	140	105 x 85	80 x 60	9	350
WB 100/50/5	100	50	148	135 x 110	105 x 80	11	600
WB 125/40/5 L	125	40	165	105 x 85	80 x 60	9	350
WB 125/50/5	125	50	178	135 x 110	105 x 80	11	700
WB 150/50/5	150	50	205	135 x 110	105 x 80	11	750
WB 175/50/5	175	50	228	135 x 110	105 x 80	11	750
WB 200/50/5	200	50	250	135 x 110	105 x 80	11	750
WB 250/50/5	250	50	307	200 x 160	160 x 120	15	1.000
WB 300/60/5	300	60	347	200 x 160	160 x 120	15	1.400

### Heavy-duty industrial fixed castors

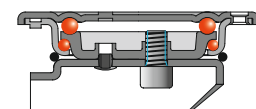

### Industrial swivel castor brackets with a load capacity of up to 1,400 kg

Housings made of strong pressed steel, zinc and chromated. Swivel head with double ball bearings, dust and splash proof. Without kingpin. With grease nipple. ALLSTOP total locking device on the trailing side of the housing, blocks rolling and swivel motion simultaneously.

ALLSTOP total locking device  
Code: WLF...



4-way directional lock  
Code: WL...4RIF



wheel and directional lock  
Code: WLF.../...4RIF



foot protection  
Code: ...PRO



PEVOLON® - PEVOLASTIC®  
PEVOTHA®

Solid rubber  
wheels and castors

Electrically conductive  
wheels and castors

VULKOLLAN® - PEVOPIUR®  
PEVODIN® / -Soft

Stainless steel castors

Institutional  
wheels and castors

Conveyor/guiding  
rollers and ball units

Profile rollers

Pallet rollers

Press-on tyres









# PE·VO·LON®

## heavy-duty industrial castors







Series TB/5

Series TL/5

								
Article code	mm	mm	mm	mm	mm	mm	mm	kg
TL 080/57/5	80	57	138	135 x 110	105 x 80	11	55	600
TL 100/50/5	100	50	148	135 x 110	105 x 80	11	55	600
TL 125/50/5	125	50	175	135 x 110	105 x 80	11	55	700
TL 150/50/5	150	50	202	135 x 110	105 x 80	11	55	800
TL 175/50/5	175	50	240	135 x 110	105 x 80	11	60	800
TL 200/50/5	200	50	252	135 x 110	105 x 80	11	60	1.000
TL 250/50/5	250	50	300	135 x 110	105 x 80	11	65	1.000

### Heavy-duty industrial swivel castors with PEVOLON® wheels

Wheels series A with ball bearings (/5), see page 37.

								
Article code	mm	mm	mm	mm	mm	mm	mm	kg
TB 080/57/5	80	57	138	135 x 110	105 x 80	11	600	
TB 100/50/5	100	50	148	135 x 110	105 x 80	11	600	
TB 125/50/5	125	50	175	135 x 110	105 x 80	11	700	
TB 150/50/5	150	50	202	135 x 110	105 x 80	11	800	
TB 175/50/5	175	50	240	135 x 110	105 x 80	11	800	
TB 200/50/5	200	50	252	135 x 110	105 x 80	11	1.000	
TB 250/50/5	250	50	300	135 x 110	105 x 80	11	1.000	

### Heavy-duty industrial fixed castors

ALLSTOP total locking device not available for wheel diameter 80 mm.

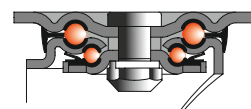

### Industrial swivel castor brackets with a load capacity of up to 1,000 kg

Housings made of extra strong pressed steel, zinc and chromated. Swivel head with double ball bearing. Bearing shells made of hardened steel. Kingpin bolted and secured. ALLSTOP total locking device on the trailing side of the housing, blocks rolling and swivel motion simultaneously.

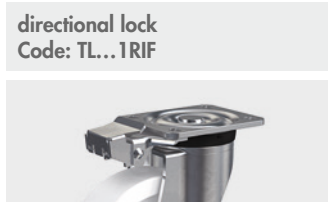

# PE·VO·LON®

## heavy-duty castors











Series UBC

Series ULC

 Article code	 mm	 mm	 mm	 mm	 mm	 mm	 mm	 kg
ULC 125/50/5	125	50	170	140 x 110	105 x 80	13	47	700
ULC 150/50/5	150	50	200	140 x 110	105 x 80	13	55	800
ULC 200/50/5	200	50	245	140 x 110	105 x 80	13	60	1.000
ULC 200/65/5	200	65	255	175 x 140	140 x 105	15	65	1.300
ULC 250/50/5	250	50	305	175 x 140	140 x 105	15	75	1.500
ULC 300/60/5	300	60	355	175 x 140	140 x 105	15	85	2.000

### Heavy-duty swivel castors with PEVOLON® wheels

Wheels series A with ball bearings (1/5), see page 37.

 Article code	 mm	 mm	 mm	 mm	 mm	 mm	 kg
UBC 125/50/5	125	50	170	140 x 110	105 x 80	13	700
UBC 150/50/5	150	50	200	140 x 110	105 x 80	13	800
UBC 200/50/5	200	50	245	140 x 110	105 x 80	13	1.000
UBC 200/65/5	200	65	255	175 x 140	140 x 105	15	1.300
UBC 250/50/5	250	50	305	175 x 140	140 x 105	15	1.500
UBC 300/60/5	300	60	355	175 x 140	140 x 105	15	2.000

### Heavy-duty fixed castors

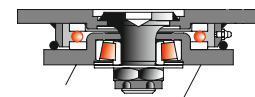

### Precision heavy-duty swivel castor brackets with a load capacity of up to 2,000 kg

Housings in precise highly stable welded steel construction. Swivel head with a high quality thrust ball bearing and a tapered roller bearing for the guidance of the kingpin. All bearing parts dust and splash proof. ALLSTOP total locking device on the non-trailing side of the housing, blocks rolling and swivel motion simultaneously.

ALLSTOP total locking device  
Code: ULCF...



4-way directional lock  
Code: ULC...4RIF



wheel and directional lock  
Code: ULCF...4RIF



foot protection  
Code: ...PRO



PEVOLON® - PEVOLASTIC®  
PEVOTHAN®

Solid rubber  
wheels and castors

Electrically conductive  
wheels and castors

VULKOLLAN® - PEVOPIUR®  
PEVODYN® / -Soft

Stainless steel castors

Institutional  
wheels and castors

Conveyor/guiding  
rollers and ball units

Profile rollers

Pallet rollers

Press-on tyres

# PE·VO·LON®

## heavy-duty castors



Series UB

Series UL

Article code	mm	mm	mm	mm	mm	mm	mm	kg
ULCD 125/50/5	125	50	180	175 x 140	140 x 105	15	49	1.100
ULCD 150/50/5	150	50	210	200 x 160	160 x 120	15	50	1.600
ULCD 200/50/5	200	50	260	200 x 160	160 x 120	15	60	2.000
ULCD 250/50/5	250	50	320	250 x 200	210 x 160	19	70	2.400
ULCD 300/60/5	300	60	380	250 x 200	210 x 160	19	80	4.000
ULCD 400/110/5	400	110	600	500 x 400	400 x 300	32	120	20.000

### Heavy-duty twin wheel swivel castors with PEVOLON® wheels

Wheels series A with ball bearings (1/5), see page 37. Wheels Ø 400 mm series PAG, see page 38.

Article code	mm	mm	mm	mm	mm	mm	kg
UBCD 125/50/5*	125	50	180	175 x 140	140 x 105	15	1.100
UBCD 150/50/5	150	50	210	200 x 160	160 x 120	15	1.600
UBCD 200/50/5	200	50	260	200 x 160	160 x 120	15	2.000
UBCD 250/50/5	250	50	320	250 x 200	210 x 160	19	2.400
UBCD 300/60/5*	300	60	380	250 x 200	210 x 160	19	4.000
UBCD 400/110/5*	400	110	600	500 x 400	400 x 300	32	20.000

\* Plate alignment: long side is parallel with wheel axle.

### Heavy-duty twin wheel fixed castors

### Precision heavy-duty swivel castor brackets with a load capacity of up to 20,000 kg

Housings in precise highly stable welded steel construction. Swivel head with a high quality thrust ball bearing and a tapered roller bearing for the guidance of the kingpin. All bearing parts dust and splash proof. Wheel locking device on the non-trailing side of the housing.

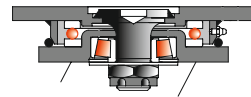

wheel locking device  
Code: ULCDRF...



4-way directional lock  
Code: ULCD...4RIF



wheel and directional lock  
Code: ULCDRF...4RIF

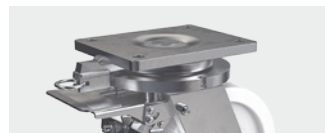

foot protection  
Code: ...PRO



PEVOLON® - PEVOLASTIC®  
PEVOTHAN®  
Solid rubber wheels and castors  
Electrically conductive wheels and castors  
VULKOLLAN® - PEVOPLUR® PEVODYN® - Soft  
Stainless steel castors  
Institutional wheels and castors  
Conveyor/guiding rollers and ball units  
Profile rollers  
Pallet rollers  
Press-on tyres







# PE·VO·LON®

## heavy-duty castors











Series UB PAG

Series UL PAG

 Article code	 mm	 mm	 mm	 mm	 mm	 mm	 mm	 kg
UL PAG/150/55/5	150	55	200	140 x 110	105 x 80	11	55	1.750
UL PAG/200/80/5	200	80	280	255 x 200	210 x 160	18	75	4.500
UL PAG/250/80/5	250	80	330	255 x 200	210 x 160	18	80	6.000
UL PAG/300/80/5	300	80	380	255 x 200	210 x 160	18	90	6.000
UL PAG/400/110/5	400	110	530	400 x 300	340 x 240	26	125	12.000

### Heavy-duty swivel castors with polyamide wheels

Wheels series PAG with ball bearings (/5), see page 38.

 Article code	 mm	 mm	 mm	 mm	 mm	 mm	 mm	 kg
UB PAG/150/55/5	150	55	200	140 x 110	105 x 80	11	55	1.750
UB PAG/200/80/5	200	80	280	255 x 200	210 x 160	18	75	4.500
UB PAG/250/80/5	250	80	330	255 x 200	210 x 160	18	80	6.000
UB PAG/300/80/5	300	80	380	255 x 200	210 x 160	18	90	6.000
UB PAG/400/110/5	400	110	530	400 x 300	340 x 240	26	125	12.000

### Heavy-duty fixed castors

### Precision heavy-duty swivel castor brackets with a load capacity of up to 12,000 kg

Housings in precise highly stable welded steel construction. Swivel head with a high quality thrust ball bearing and a tapered roller bearing for the guidance of the kingpin. All bearing parts dust and splash proof. Wheel locking device on the non-trailing side of the housing.

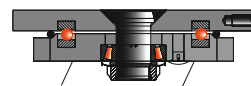

wheel locking device  
Code: UL RF PAG/...



4-way directional lock  
Code: UL PAG/...4RIF



wheel and directional lock  
Code: UL RF PAG/...4RIF



foot protection  
Code: ...PRO



# PE·VO·LASTIC®/PE·VO·THAN® wheels

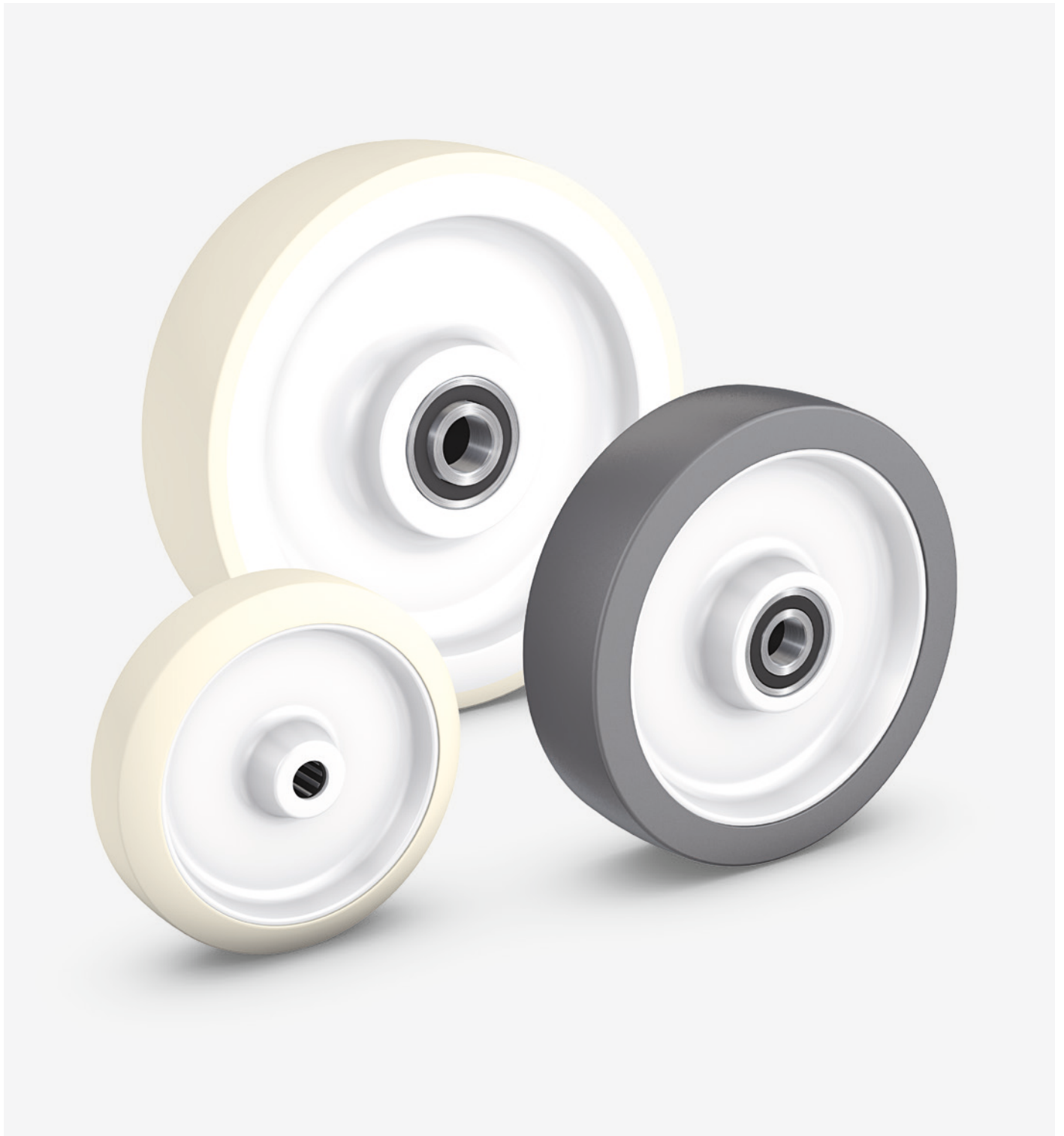

PEVOLON® • PEVOLASTIC®  
PEVOTHAN®

Solid rubber  
wheels and castors

Electrically conductive  
wheels and castors

VULKOLLAN® • PEVOPUR®  
PEVODYN® / -Soft

Stainless steel castors

Institutional  
wheels and castors

Conveyor/guiding  
rollers and ball units

Profile rollers

Pallet rollers

Press-on tyres

# PE·VO·LASTIC®/PE·VO·THAN® product overview

## PEVOLASTIC®/PEVOTHAN® WHEELS AND CASTORS

PEVOLASTIC® and PEVOTHAN® wheels consist of a PEVOLON® rim with a mechanically non-detachable, fixed polyurethane tread (Desmopan® from Bayer AG, Leverkusen). The excellent Desmopan® properties include high load capacity, non-marking properties, high abrasion resistance and good damping power.

Due to its physical, thermal and chemical properties, it is superior to all standard rubber wheels and is thus recommended for sensitive surfaces.

The dimensions of the precise processed swivel and fixed castor housings fulfil to the standards of the European manufacturers of castors.

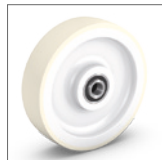

Series APU  
60 - 1.100 kg  
[Page 50](#)



Series 89 PU  
100 - 400 kg  
[Page 51](#)



Series 87 PU  
150 - 500 kg  
[Page 52](#)



Series 31 PU/32 PU  
100 - 400 kg  
[Page 54](#)



Series 51 PU/52 PU  
120 - 400 kg  
[Page 55 - 56](#)



Series WL PU  
Series WB PU  
150 - 500 kg  
[Page 57](#)



# PE·VO·LASTIC® wheels

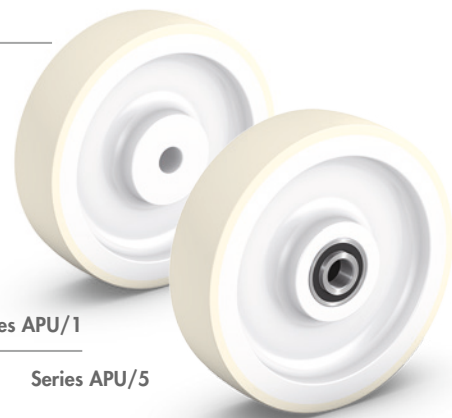

Series APU/1

Series APU/5

Article code	mm	mm	mm	mm	mm	mm	kg
APU 050/020/1/10	50	20	30	–	18	10	60
APU 080/027/1/10	80	27	35	–	18	10	75
APU 100/038/1/12	100	38	40	–	45	12	150
APU 125/040/1/15	125	40	50	–	45	15	225
APU 160/042/1/15	160	42	50	–	45	15	400
APU 200/050/1/20	200	50	55	–	68	20	800
APU 250/055/1/25	250	55	60	–	70	25	1.000
APU 300/060/1/25	300	60	65	–	70	25	1.100
APU 100/038/5/15	100	38	40	38	45	15	150
APU 125/040/5/15	125	40	50	48	45	15	225
APU 160/042/5/15	160	42	50	48	45	15	400
APU 200/050/5/20	200	50	52	57	68	20	800
APU 250/055/5/20	250	55	60	64	70	20	1.000
APU 250/055/5/25	250	55	60	64	70	25	1.000
APU 300/060/5/20	300	60	65	69	70	20	1.100
APU 300/060/5/25	300	60	65	69	70	25	1.100

## Heavy-duty PEVOLASTIC® wheels

PEVOLON® rim with a tread made of high-quality thermoplastic polyurethane (95° Shore A), with plain bearing (/1) or ball bearings (/5).

PEVOLON® • PEVOLASTIC®  
PEVOTHA®

Solid rubber  
wheels and castors

Electrically conductive  
wheels and castors

VULVOLAN® • PEVOPUR®  
PEVDIV® - Soft

Stainless steel castors

Institutional  
wheels and castors

Conveyor/guiding  
rollers and ball units

Profile rollers

Pallet rollers

Press-on tyres

# PE·VO·THAN® wheels

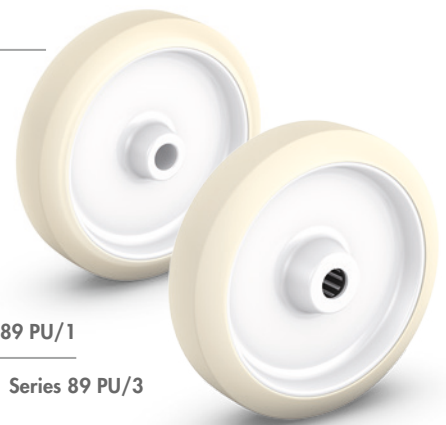

Series 89 PU/1

Series 89 PU/3

Article code	mm	mm	mm	mm	mm	kg
89 PU/080/035/1/12	80	35	40	20	12	100
89 PU/100/034/1/12	100	34	40	22	12	140
89 PU/125/037/1/15	125	37	47	26	15	180
89 PU/150/045/1/20	150	45	50	35	20	225
89 PU/160/050/1/20	160	50	60	35	20	250
89 PU/200/050/1/20	200	50	60	35	20	400
89 PU/080/035/3/10	80	35	40	26	10	100
89 PU/100/034/3/10	100	34	40	26	10	140
89 PU/125/037/3/15	125	37	47	32	15	180
89 PU/150/045/3/15	150	45	50	35	15	225
89 PU/160/050/3/15	160	50	60	35	15	250
89 PU/200/050/3/20	200	50	60	42	20	400
89 PU/080/035/3R/10	80	35	40	26	10	100
89 PU/100/034/3R/10	100	34	40	26	10	140
89 PU/125/037/3R/15	125	37	47	32	15	180
89 PU/150/045/3R/15	150	45	50	35	15	225
89 PU/160/050/3R/15	160	50	60	35	15	250
89 PU/200/050/3R/20	200	50	60	42	20	400

## PEVOTHAN® wheels

PEVOLON® rim with a tread made of high-quality thermoplastic polyurethane (80° Shore A), with plain bearing (/1), roller bearing (/3) or stainless roller bearing (/3R).

PEVOLON® • PEVOLASTIC®  
PEVOTHAN®

Solid rubber wheels and castors

Electrically conductive wheels and castors

VULKOLLAN® • PEVOPUR®  
PEVODYN® / -Soft

Stainless steel castors

Institutional wheels and castors

Conveyor/guiding rollers and ball units

Profile rollers

Pallet rollers





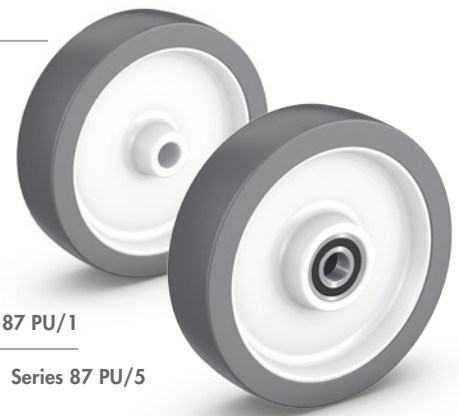

Press-on tyres

# PE·VO·THAN® wheels



Series 87 PU/1

Series 87 PU/5

Article code	 mm	 mm	 mm	 mm	 mm	 mm	 kg
87 PU/080/035/1/12	80	35	40	–	20	12	150
87 PU/100/040/1/15	100	40	50	–	25	15	200
87 PU/125/045/1/15	125	45	50	–	25	15	250
87 PU/150/045/1/20	150	45	50	–	35	20	380
87 PU/160/050/1/20	160	50	60	–	35	20	430
87 PU/200/050/1/20	200	50	60	–	35	20	500
87 PU/080/035/5/08	80	35	35	41	–	08	150
87 PU/080/035/5/12	80	35	35	31	–	12	150
87 PU/100/040/5/10	100	40	45	51	45	10	200
87 PU/100/040/5/15	100	40	45	41	45	15	200
87 PU/125/045/5/12	125	45	45	51	45	12	250
87 PU/125/045/5/15	125	45	45	41	45	15	250
87 PU/150/045/5/12	150	45	45	51	65	12	380
87 PU/150/045/5/20	150	45	45	41	65	20	380
87 PU/160/050/5/12	160	50	55	61	65	12	430
87 PU/160/050/5/20	160	50	55	51	65	20	430
87 PU/200/050/5/12	200	50	55	61	60	12	500
87 PU/200/050/5/20	200	50	55	51	60	20	500
87 PU/080/035/5R/12	80	35	35	31	41	12	150
87 PU/100/040/5R/15	100	40	45	41	45	15	160
87 PU/125/045/5R/15	125	45	45	41	45	15	200
87 PU/150/045/5R/20	150	45	45	41	65	20	380
87 PU/160/050/5R/20	160	50	55	51	65	20	430
87 PU/200/050/5R/20	200	50	55	51	60	20	500

## PEVOTHAN® wheels

PEVOLON® rim with a tread made of high-quality thermoplastic polyurethane (96° Shore A), with plain bearing (/1), ball bearings (/5) or stainless ball bearings (/5R).

PEVOLON® • PEVOLASTIC®  
PEVOTHAN®  
Solid rubber wheels and castors  
Electrically conductive wheels and castors  
VULVOLAN® • PEVOPUR® PEVODIN® / -Soft  
Stainless steel castors  
Institutional wheels and castors  
Conveyor/guiding rollers and ball units  
Profile rollers  
Pallet rollers  
Press-on tyres

# PE·VO·THAN® industrial castors



PEVOLON® - PEVOPLASTIC®  
PEVOTHAN®

Solid rubber  
wheels and castors

Electrically conductive  
wheels and castors

VULKOLLAN® - PEVOPUR®  
PEVODYN® / -Soft

Stainless steel castors

Institutional  
wheels and castors

Conveyor/guiding  
rollers and ball units

Profile rollers

Pallet rollers

Press-on tyres

# PE·VO·THAN® industrial castors



Series 32 PU

Series 31 PU

Article code	mm	mm	mm	mm	mm	mm	mm	kg
31 PU/080/35/1 L	80	35	108	105 x 85	80 x 60	9	38	100
31 PU/100/34/1 L	100	34	128	105 x 85	80 x 60	9	38	140
31 PU/125/37/1 L	125	37	155	105 x 85	80 x 60	9	45	180
31 PU/150/45/1	150	45	194	135 x 110	105 x 80	11	55	225
31 PU/200/50/1	200	50	239	135 x 110	105 x 80	11	55	400
31 PU/080/35/3 L	80	35	108	105 x 85	80 x 60	9	38	100
31 PU/100/34/3 L	100	34	128	105 x 85	80 x 60	9	38	140
31 PU/125/37/3 L	125	37	155	105 x 85	80 x 60	9	45	180
31 PU/160/50/3	160	50	199	135 x 110	105 x 80	11	55	250
31 PU/200/50/3	200	50	239	135 x 110	105 x 80	11	55	400

Article code	mm	mm	mm	mm	mm	mm	kg
32 PU/080/35/1 L	80	35	108	105 x 85	80 x 60	9	100
32 PU/100/34/1 L	100	34	128	105 x 85	80 x 60	9	140
32 PU/125/37/1 L	125	37	155	105 x 85	80 x 60	9	180
32 PU/150/45/1	150	45	194	135 x 110	105 x 80	11	225
32 PU/200/50/1	200	50	239	135 x 110	105 x 80	11	400
32 PU/080/35/3 L	80	35	108	105 x 85	80 x 60	9	100
32 PU/100/34/3 L	100	34	128	105 x 85	80 x 60	9	140
32 PU/125/37/3 L	125	37	155	105 x 85	80 x 60	9	180
32 PU/160/50/3	160	50	199	135 x 110	105 x 80	11	250
32 PU/200/50/3	200	50	239	135 x 110	105 x 80	11	400

## Industrial swivel castors with PEVOHAN® wheels

PEVOHAN® wheels series 89 PU (80° Shore A) with plain bearing (/1) or roller bearing (/3), see page 51.

## Industrial fixed castors

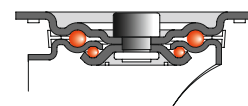

## Industrial swivel castor brackets with a load capacity of up to 400 kg

Housings made of pressed steel, zinc and chromated. Swivel head with double ball bearings, dust and splash proof, with riveted kingpin. ALLSTOP total locking device on the trailing side of the housing, blocks rolling and swivel motion simultaneously.

**ALLSTOP total locking device**  
Code: 31 F PU/...

**foot protection**  
Code: ...PRO

**single bolt hole**  
Code: 31 PU/...R

**stem fitting**  
Code: 31 Z PU/...

**single bolt hole/total lock**  
Code: 31 F PU/...R

**stem fitting/total locking device**  
Code: 31 FZ PU/...

# PE·VO·THAN® industrial castors



Series 52 PU/1

Series 51 PU/1

Article code	mm	mm	mm	mm	mm	mm	mm	kg
51 PU/080/35/1 L	80	35	108	105 x 85	80 x 60	9	38	120
51 PU/100/40/1	100	40	126	135 x 110	105 x 80	11	40	200
51 PU/125/45/1	125	45	164	135 x 110	105 x 80	11	55	250
51 PU/150/45/1	150	45	194	135 x 110	105 x 80	11	55	300
51 PU/160/50/1	160	50	199	135 x 110	105 x 80	11	55	300
51 PU/200/50/1	200	50	239	135 x 110	105 x 80	11	55	400

## Industrial swivel castors with PEVO THAN® wheels (plain bearing)

Wheels series 87 PU with plain bearing (/1), see page 52.

Article code	mm	mm	mm	mm	mm	mm	kg
52 PU/080/35/1 L	80	35	108	105 x 85	80 x 60	9	120
52 PU/100/40/1	100	40	126	135 x 110	105 x 80	11	200
52 PU/125/45/1	125	45	164	135 x 110	105 x 80	11	250
52 PU/150/45/1	150	45	194	135 x 110	105 x 80	11	300
52 PU/160/50/1	160	50	199	135 x 110	105 x 80	11	300
52 PU/200/50/1	200	50	239	135 x 110	105 x 80	11	400

1-way directional lock only available for plate 135 x 110 mm.

## Industrial fixed castors

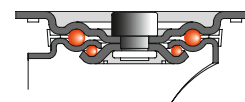

## Industrial swivel castor brackets with a load capacity of up to 400 kg

Housings made of pressed steel, zinc and chromated. Swivel head with double ball bearings, dust and splash proof, with riveted kingpin. ALLSTOP total locking device on the trailing side of the housing, blocks rolling and swivel motion simultaneously.

\* with locking device code: 51 FZ PU/..

**ALLSTOP total locking device**  
Code: 51 F PU/...

**directional lock**  
Code: 51 PU/...TRIF

**single bolt hole**  
Code: 51 PU/...R

**foot protection**  
Code: ...PRO

**single bolt hole/total lock**  
Code: 51 F PU/...R

**stem fitting**  
Code: 51 Z PU/...\*

PEVOPLAN® - PEVOPLASTIC®  
PEVO THAN®

Solid rubber wheels and castors

Electrically conductive wheels and castors

VULKOLLAN® - PEVOPLAN®  
PEVOPLAN® - Soft

Stainless steel castors

Institutional wheels and castors

Conveyor/guiding rollers and ball units

Profile rollers

Puller rollers





Press-on tyres

# PE·VO·THAN® industrial castors







Series 52 PU/5

Series 51 PU/5

								
Article code	mm	mm	mm	mm	mm	mm	mm	kg
51 PU/080/35/5 L	80	35	108	105 x 85	80 x 60	9	38	120
51 PU/100/40/5	100	40	126	135 x 110	105 x 80	11	40	200
51 PU/125/45/5	125	45	164	135 x 110	105 x 80	11	55	250
51 PU/150/45/5	150	45	194	135 x 110	105 x 80	11	55	300
51 PU/160/50/5	160	50	199	135 x 110	105 x 80	11	55	300
51 PU/200/50/5	200	50	239	135 x 110	105 x 80	11	55	400

## Industrial swivel castors with PEVOTHAN® wheels

Pressed steel bracket. With wheels series 87 PU with ball bearings (/5), see page 52.

							
Article code	mm	mm	mm	mm	mm	mm	kg
52 PU/080/35/5 L	80	35	108	105 x 85	80 x 60	9	120
52 PU/100/40/5	100	40	126	135 x 110	105 x 80	11	200
52 PU/125/45/5	125	45	164	135 x 110	105 x 80	11	250
52 PU/150/45/5	150	45	194	135 x 110	105 x 80	11	300
52 PU/160/50/5	160	50	199	135 x 110	105 x 80	11	300
52 PU/200/50/5	200	50	239	135 x 110	105 x 80	11	400

## Industrial fixed castors

1-way directional lock not available for plate 105 x 85 mm.

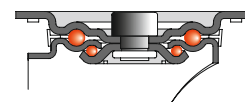

## Industrial swivel castor brackets with a load capacity of up to 400 kg

Housings made of pressed steel, zinc and chromated. Swivel head with double ball bearings, dust and splash proof, with riveted kingpin. ALLSTOP total locking device on the trailing side of the housing, blocks rolling and swivel motion simultaneously.

\* with locking device code: 51 FZ PU/..

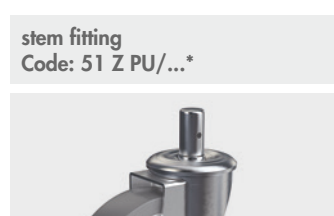
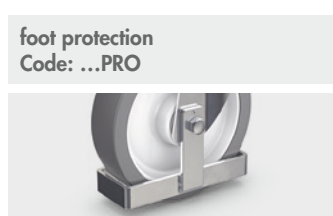
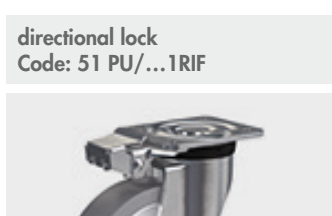
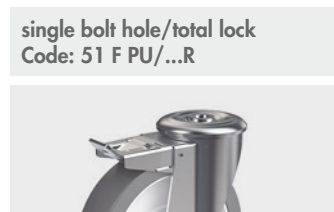
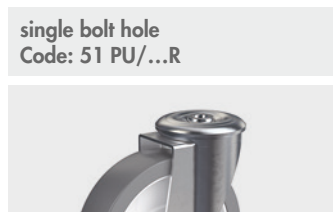
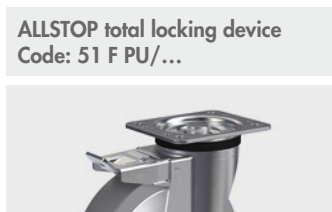

# PE·VO·THAN®

## heavy-duty industrial castors



Series WB PU/5

Series WL PU/5

### Heavy-duty industrial swivel castors with PEVOTHAN® wheels

Wheels series 87 PU with ball bearings (1/5), see page 52.

Article code	mm	mm	mm	mm	mm	mm	mm	kg
WL PU/080/35/5 L	80	35	118	105 x 85	80 x 60	9	40	150
WL PU/100/40/5 L	100	40	140	105 x 85	80 x 60	9	45	200
WL PU/100/40/5	100	40	148	135 x 110	105 x 80	11	50	200
WL PU/125/45/5 L	125	45	165	105 x 85	80 x 60	9	45	250
WL PU/125/45/5	125	45	178	135 x 110	105 x 80	11	50	250
WL PU/150/45/5	150	45	205	135 x 110	105 x 80	11	50	380
WL PU/160/50/5	160	50	210	135 x 110	105 x 80	11	50	430
WL PU/200/50/5	200	50	250	135 x 110	105 x 80	11	55	500

### Industrial fixed castors

Article code	mm	mm	mm	mm	mm	mm	kg
WB PU/080/35/5 L	80	35	118	105 x 85	80 x 60	9	150
WB PU/100/40/5 L	100	40	140	105 x 85	80 x 60	9	200
WB PU/100/40/5	100	40	148	135 x 110	105 x 80	11	200
WB PU/125/45/5 L	125	45	165	105 x 85	80 x 60	9	250
WB PU/125/45/5	125	45	178	135 x 110	105 x 80	11	250
WB PU/150/45/5	150	45	205	135 x 110	105 x 80	11	380
WB PU/160/50/5	160	50	210	135 x 110	105 x 80	11	430
WB PU/200/50/5	200	50	250	135 x 110	105 x 80	11	500

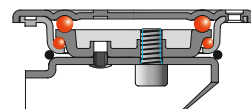

### Industrial swivel castor brackets with a load capacity of up to 500 kg

Housings made of strong pressed steel, zinc and chromated. Swivel head with double ball bearings, dust and splash proof. Without kingpin. With grease nipple. ALLSTOP total locking device on the trailing side of the housing, blocks rolling and swivel motion simultaneously.

ALLSTOP total locking device  
Code: WLF PU/...



4-way directional lock  
Code: WL PU/...4RIF



wheel and directional lock  
Code: WLF PU/...4RIF



foot protection  
Code: ...PRO



PEVOLAN® - PEVOELASTIC®  
PEVOTHAN®

Solid rubber  
wheels and castors

Electrically conductive  
wheels and castors

VULKOLAN® - PEVOPIUR®  
PEVODIN® - Soft

Stainless steel castors

Industrial  
wheels and castors

Conveyor/guiding  
rollers and ball units

Profile rollers

Pallet rollers

Press-on tyres



# Solid rubber wheels



PEVOLON® • PEVOPLASTIC®  
PEVOTHA®

Solid rubber  
wheels and castors

Electrically conductive  
wheels and castors

VULKOLLAN® • PEVOPUK®  
PEVODYN® / -Soft

Stainless steel castors

Institutional  
wheels and castors

Conveyor/guiding  
rollers and ball units

Profile rollers

Pallet rollers

Press-on tyres

# Solid rubber product overview

## Solid rubber WHEELS AND CASTORS

Different rubber qualities and wheel centres determine the potential applications of this wheel series.

From simple solid rubber wheels on a plastic rim to high-quality welded-steel constructions with SUPER ELASTIC tyres, we produce solid rubber wheels for many different types of usage. The precise workmanship insures the functionality of the swivel and fixed castor casing.

Compact brake systems offer long-lasting, secure locking for all areas of application. The dimensions fulfil to the standards of the European manufacturers of castors.



Series 80/80 EX  
Series 80 HE  
50 - 300 kg  
[Page 60](#)

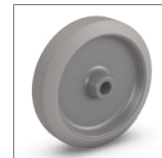

Series 89 PS  
80 - 300 kg  
[Page 61](#)



Series 74  
160 - 400 kg  
[Page 62](#)



Series 76  
140 - 600 kg  
[Page 62](#)



Series 73  
160 - 650 kg  
[Page 63](#)



Series 83 ST  
350 - 800 kg  
[Page 63](#)



Series 70 A  
Series 70/5  
700 - 6.000 kg  
[Page 64 - 65](#)



Series 91  
75 - 250 kg  
[Page 66](#)



Series 90/90 SE  
250 - 2.400 kg  
[Page 67](#)



Series 31/32  
Series 31 HE/32 HE  
50 - 350 kg  
[Page 69 - 70](#)



Series 31 PS/32 PS  
80 - 300 kg  
[Page 71](#)

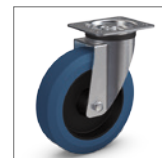

Series 27 Stage  
Series 28 Stage  
100 - 300 kg  
[Page 72](#)



Series 21/22  
140 - 400 kg  
[Page 73](#)



Series 23/24  
Series 25/26  
160 - 700 kg  
[Page 74 - 75](#)



Series 39/40  
50 - 250 kg  
[Page 76](#)









Series 1 B/2 B  
350 - 800 kg  
[Page 77](#)

# Solid rubber wheels









Series 80/3

 Article code	 mm	 mm	 mm	 mm	 kg
80/080/025/3/12	80	25	40	12	50
80/100/030/3/12	100	30	40	12	70
80/125/037/3/15	125	37	46	15	100
80/160/040/3/20	160	40	60	20	135
80/180/045/3/20	180	45	60	20	170
80/200/050/3/20	200	50	60	20	205
80/250/060/3/20	250	60	65	20	290
80/280/060/3/25	280	60	75	25	295







## Solid rubber wheels

Pressed steel rim with standard quality black solid rubber tyre with roller bearing (/3).

 Article code	 mm	 mm	 mm	 mm	 kg
80 EX/080/025/3/12	80	25	40	12	50
80 EX/100/030/3/12	100	30	40	12	70
80 EX/125/037/3/15	125	37	46	15	100
80 EX/160/040/3/20	160	40	60	20	135
80 EX/200/050/3/20	200	50	60	20	205

## Electrically conductive solid rubber wheels

Pressed steel rim with electrically conductive black solid rubber tyre with roller bearing (/3).

 Article code	 mm	 mm	 mm	 mm	 kg
80 HE/100/030/3/12	100	30	40	12	100
80 HE/125/037/3/15	125	37	50	15	120
80 HE/160/040/3/20	160	40	58	20	200
80 HE/180/045/3/20	180	45	58	20	250
80 HE/200/050/3/20	200	50	58	20	300

## ELASTIC solid rubber wheels







Pressed steel rim with black ELASTIC solid rubber tyre with roller bearing (/3).

Solid rubber wheels series 80, 80 EX and 80 HE with ball bearings (/5) available on request.

# Solid rubber wheels



Series 89 PS/1

Article code	 mm	 mm	 mm	 mm	 mm	 mm	 kg
89 PS/080/035/1/12	80	35	40	20	12		80
89 PS/100/034/1/12	100	34	40	22	12		100
89 PS/125/037/1/15	125	37	47	26	15		120
89 PS/150/045/1/20	150	45	50	35	20		180
89 PS/160/050/1/20	160	50	60	35	20		200
89 PS/200/050/1/20	200	50	60	35	20		300
89 PS/080/035/3/10	80	35	40	26	10		80
89 PS/100/034/3/10	100	34	40	26	10		100
89 PS/125/037/3/15	125	37	47	32	15		120
89 PS/150/045/3/15	150	45	50	35	15		180
89 PS/160/050/3/15	160	50	60	35	15		200
89 PS/200/050/3/20	200	50	60	42	20		300
89 PS/080/035/3R/10	80	35	40	26	10		80
89 PS/100/034/3R/10	100	34	40	26	10		100
89 PS/125/037/3R/15	125	37	47	32	15		120
89 PS/150/045/3R/15	150	45	50	35	15		180
89 PS/160/050/3R/15	160	50	60	35	15		200
89 PS/200/050/3R/20	200	50	60	42	20		300

## Thermoplastic rubber wheels

Plastic rim with non-marking tyres made of thermoplastic rubber elastomer, with plain bearing (/1), roller bearing (/3) or stainless roller bearing (/3R).

PEVOLON® • PEVOLASTIC®  
PEVOTHA®

Solid rubber wheels and castors

Electrically conductive wheels and castors

VULKOLLAN® • PEVOPIUR®  
PEVODIN® • Soft

Stainless steel castors

Institutional wheels and castors

Conveyor/guiding rollers and ball units

Profile rollers

Pallet rollers

Press-on tyres

# ELASTIC solid rubber wheels



Series 76/5

Series 74/3

Article code	mm	mm	mm	mm	mm	kg
74/100/032/3/12	100	32	40	–	12	160
74/125/040/3/15	125	40	45	–	15	225
74/160/050/3/20	160	50	60	–	20	300
74/200/050/3/20	200	50	60	–	20	400
74/100/036/3R/12	100	36	40	–	12	160
74/125/036/3R/15	125	36	50	–	15	225
74/160/050/3R/20	160	50	58	–	20	300
74/200/050/3R/20	200	50	60	–	20	400
74/125/040/5/15	125	40	45	45	15	175
74/160/050/5/20	160	50	45	40	20	300
74/200/050/5/20	200	50	58	58	20	400

## ELASTIC solid rubber wheels

Plastic rim with non-marking, securely vulcanised ELASTIC solid rubber tyre (blue) with roller bearing (/3), stainless roller bearing (/3R) or ball bearings (/5).

Article code	mm	mm	mm	mm	mm	kg
76/100/032/3/12	100	32	45	–	12	140
76/125/040/3/15	125	40	48	–	15	180
76/160/050/3/20	160	50	58	–	20	300
76/200/050/3/20	200	50	58	–	20	400
76/125/040/5/15	125	40	48	48	15	180
76/160/050/5/20	160	50	58	58	20	300
76/200/050/5/20	200	50	58	58	20	450
76/250/050/5/25	250	50	55	61	25	500
76/200/050/1/25 F8*	200	50	50	–	25	400
76/250/048/1/25 G7*	250	48	60	–	25	500
76/300/050/1/30 F8*	300	50	60	–	30	600

## ELASTIC solid rubber wheels

Plastic rim with securely vulcanised ELASTIC solid rubber tyre with roller bearing (/3) or ball bearings (/5).







\* With plain bearing (/1) and sintered bronze bushings: wheels for the specific use in environmental technology (for underwater use in sewage treatment plants etc. for example)

# ELASTIC solid rubber wheels









Series 83 ST/5

Series 73/5

 Article code	 mm	 mm	 mm	 mm	 mm	 kg
73/100/040/5/15	100	40	45	45	15	160
73/125/040/5/15	125	40	45	45	15	180
73/125/050/5/20	125	50	54	60	20	225
73/125/050/5/25	125	50	54	60	25	225
73/160/050/5/20	160	50	54	60	20	300
73/160/050/5/25	160	50	54	60	25	300
73/180/050/5/20	180	50	54	60	20	350
73/180/050/5/25	180	50	54	60	25	350
73/200/050/5/20-1	200	50	54	54	20	400
73/200/050/5/20-2	200	50	54	60	20	400
73/200/050/5/25	200	50	54	60	25	400
73/250/050/5/20	250	50	54	60	20	500
73/250/050/5/25	250	50	54	60	25	500
73/300/060/5/30-1	300	60	60	60	30	650
73/300/060/5/30-2	300	60	75	74	30	650

## ELASTIC solid rubber wheels

Aluminium rim with securely vulcanised ELASTIC solid rubber tyre with ball bearings (/5).

 Article code	 mm	 mm	 mm	 mm	 mm	 kg
83 ST/160/050/5/25	160	50	50	50	25	350
83 ST/200/050/5/25	200	50	50	50	25	400
83 ST/200/080/5/30	200	80	80	80	30	600
83 ST/250/050/5/25	250	50	50	50	25	400
83 ST/250/060/5/30	250	60	60	60	30	500
83 ST/250/080/5/30	250	80	80	80	30	700
83 ST/300/075/5/30	300	75	75	75	30	800

## ELASTIC solid rubber wheels

Highly stable pressed steel rim, with securely vulcanised ELASTIC solid rubber tyre with ball bearings (/5).

# Solid rubber heavy-duty drive wheels

Series 70/A



Article code	mm	mm	mm	mm	mm	kg
70 A/300/075/240/2/50 H7	300	75	65	78	50	700
70 A/360/060/270/2/40 H7	360	60	70	66	40	750
70 A/360/075/270/2/45 H7	360	75	100	66	45	950
70 A/360/085/270/2/50 H7	360	85	95	78	50	1.050
70 A/360/150/270/2/50 H7	360	150	160	78	50	1.900
70 A/405/065/305/2/50 H7	405	65	80	78	50	900
70 A/405/130/305/2/50 H7	405	130	130	78	50	1.500
70 A/415/075/305/2/50 H7	415	75	90	78	50	1.000
70 A/415/090/305/2/60 H7	415	90	100	91	60	1.150
70 A/415/100/305/2/55 H7	415	100	120	97	55	1.250
70 A/425/150/305/2/70 H7	425	150	160	102	70	1.800
70 A/500/085/370/2/60 H7	500	85	95	91	60	1.300
70 A/520/100/370/2/60 H7	520	100	95	91	60	1.525
70 A/540/200/410/2/60 H7	540	200	210	91	60	3.270
70 A/550/160/410/2/50 J7	550	160	160	78	50	2.250
70 A/560/100/410/2/60 H7	560	100	95	91	60	1.600
70 A/590/120/410/2/70 H7	590	120	95	104	70	1.900
70 A/610/150/410/2/60 H7	610	150	120	91	60	2.250
70 A/620/200/410/2/70 H7	620	200	180	104	70	3.000
70 A/645/300/410/2/75 J7	645	300	300	110	75	6.000

## Heavy-duty solid rubber drive wheels







Rim, designed as a stable welded steel construction with bore and keyway according to DIN 6885 press-on and replaceable steel band solid rubber tyre.

Heavy-duty solid rubber wheels with bolt hole fitting or for the reception of clamping sets available on request.

# Solid rubber heavy-duty wheels

Series 70/5



Article code	 mm	 mm	 mm	 mm	 mm	 mm	 kg
70/300/075/240/5/30	300	75	80	80	66	30	700
70/360/060/270/5/30	360	60	65	65	66	30	750
70/360/075/270/5/30	360	75	80	80	78	30	950
70/360/085/270/5/30	360	85	90	90	78	30	1.050
70/400/065/305/5/30	400	65	95	95	78	30	900
70/405/130/305/5/40	405	130	95	95	97	40	1.500
70/415/075/305/5/35	415	75	95	95	79	35	1.000
70/415/090/305/5/35	415	90	95	95	91	35	1.150
70/500/085/370/5/40	500	85	95	95	97	40	1.300
70/520/100/370/5/45	520	100	95	95	104	45	1.525
70/560/100/410/5/45	560	100	95	95	104	45	1.600
70/590/120/410/5/50	590	120	95	95	117	50	1.900
70/610/150/410/5/50	610	150	95	95	117	50	2.250
70/620/200/410/5/50	620	200	95	95	117	50	2.500

## Heavy-duty solid rubber wheels

Rim, designed as a stable weldet steel construction with ball bearings (/5), press-on and replaceable solid rubber tyre with steel wire core.

PEVOPUR® - PEVOPLASTIC®  
PEVOTHA®

Solid rubber  
wheels and castors

Electrically conductive  
wheels and castors

VULKOLLAN® - PEVOPUR®  
PEVODIN® - Soft

Stainless steel castors

Institutional  
wheels and castors

Conveyor/guiding  
rollers and ball units

Profile rollers

Pallet rollers





Press-on tyres



# Pneumatic tyred wheels



Series 91

Article code	 mm	 mm	Tyre	 mm	 mm	 kg
91/180/045/3/20/60 R	180	45	7 x 1 3/4 2PR rib	60	20	75
91/200/050/3/20/50 R	200	50	200 x 50 2PR rib	50	20	75
91/200/050/1/20/58 KR	200	50	200 x 50 2PR rib	58	20	75
91/200/050/3/20/60 R	200	50	200 x 50 2PR rib	60	20	75
91/210/065/3/20/50 R	210	65	2.50 - 3 2PR rib	50	20	100
91/210/065/3/20/75 R	210	65	2.50 - 3 2PR rib	75	20	100
91/220/070/3/20/75 S	220	70	2.50 - 4 2PR block	75	20	130
91/260/085/3/20/75 KS*	260	85	3.00 - 4 2PR block	75	20	125
91/260/085/3/25/75 S	260	85	3.00 - 4 2PR block	75	25	200
91/260/085/3/25/75 KS	260	85	3.00 - 4 2PR block	75	25	200
91/260/085/5/20/75 R	260	85	3.00 - 4 2PR rib	75	20	200
91/260/085/3/20/50 R	260	85	3.00 - 4 2PR rib	50	20	200
91/260/085/1/20/50 KS	260	85	3.00 - 4 2PR block	50	20	200
91/260/085/5/25/50 S	260	85	3.00 - 4 2PR block	50	25	200
91/260/085/1/20/75 KS*	260	85	3.00 - 4 2PR block	75	20	200
91/260/085/1/25/75 KS	260	85	3.00 - 4 2PR block	75	25	180
91/260/085/3/20/50 S	260	85	3.00 - 4 2PR block	50	20	200
91/260/085/3/20/75 S	260	85	3.00 - 4 2PR block	75	20	200
91/260/085/3/20/60 S**	260	85	3.00 - 4 2PR block	60	20	200
91/260/085/3/20/88 S	260	85	3.00 - 4 4PR block	88	20	200
91/260/085/3/25/88 S	260	85	3.00 - 4 2PR block	88	25	200
91/400/100/3/25/75 R	400	100	4.00 - 8 2PR rib	75	25	200
91/400/100/3/25/88 R	400	100	4.00 - 8 2PR rib	88	25	250
91/400/100/1/20/75 KS	400	100	4.00 - 8 2PR block	75	20	250
91/400/100/1/20/88 KS	400	100	4.00 - 8 4PR block	88	20	250
91/400/100/3/20/88 KR*	400	100	4.00 - 8 4PR rib	88	20	250
91/400/100/5/20/88 R	400	100	4.00 - 8 2PR rib	88	20	250
91/400/100/5/25/88 R	400	100	4.00 - 8 4PR rib	88	25	250

\* red rim

\*\* off-centered hub

## Pneumatic tyred transport wheels

Plastic (K) or pressed steel rim, with plain bearing (/1), roller bearing (/3) or ball bearings (/5).

PEVOLON® • PEVOLASTIC®  
PEVOTAN®

Solid rubber  
wheels and castors

Electrically conductive  
wheels and castors

VULKOLAN® • PEVOPUR®  
PEVODVM® - Soft

Stainless steel castors

Insituflational  
wheels and castors

Conveyor/guiding  
rollers and ball units

Profile rollers

Pallet rollers







Press-on tyres

# SUPER ELASTIC / Pneumatic tyred heavy-duty wheels







Series 90 SE/ 90(/0)

Series 90 SE/ 90(/5)

 Article code	 mm	 mm	Tyre	 mm	 mm	 mm	 kg
90/300/100/0/53/3L	300	100	4.00 - 4 6PR	-	-	53	350
90/400/100/0/60/4L	400	100	4.00 - 8 6PR	-	-	60	500
90/460/140/0/60/4L	460	140	5.00 - 8 8PR	-	-	60	840
90/540/165/0/67/5L	540	165	6.00 - 9 10PR	-	-	67	1.150
90/300/100/5/25	300	100	4.00 - 4 6PR	90	90	25	350
90/415/115/5/30	415	115	4.00 - 8 8PR	100	100	30	700
90/460/140/5/30	460	140	5.00 - 8 8PR	100	100	30	960

## Heavy industrial pneumatic tyred wheels

High-quality pressed steel rim with ball bearings (/5) or bolt hole fittings (/0).

 Article code	 mm	 mm	Tyre	 mm	 mm	 mm	 kg
90 SE/377/110/0/80/7L	377	110	15 x 4.5-8	-	-	80	800
90 SE/400/110/0/60/4L	400	110	4.00 - 8	-	-	60	720
90 SE/450/130/0/60/4L	450	130	5.00 - 8	-	-	60	750
90 SE/457/200/0/110/8L	457	200	18 x 8.0 - 10	-	-	110	2.400
90 SE/530/145/0/67/5L	530	145	6.00 - 9	-	-	67	1.450
90 SE/250/076/5/25	250	76	3.00 - 4	75	75	25	260
90 SE/250/080/5/25	250	80	3.00 - 4	58	60	25	250
90 SE/300/095/5/25	300	95	4.00 - 4	90	90	25	430
90 SE/377/110/5/50	377	110	15 x 4.5-8	135	135	50	1.000
90 SE/406/110/5/30	406	110	4.00 - 8	100	100	30	730
90 SE/460/120/5/30	460	120	5.00 - 8	100	100	30	780
90 SE/530/145/5/35	530	145	6.00 - 9	120	120	35	1.700

## Wheels with SUPER ELASTIC tyre

High-quality pressed steel rim with ball bearings (/5) or bolt hole fittings (/0).

PEVOLOP® - PEVOELASTIC®  
PEVOHAN®

Solid rubber  
wheels and castors

Electrically conductive  
wheels and castors

VULKOLLAN® - PEVOPIUR®  
PEVDIVM® - Soft

Stainless steel castors

Institutional  
wheels and castors

Conveyor/guiding  
rollers and ball units

Profile rollers

Puller rollers

Press-on tyres

# Solid rubber castors



PEVOLON® • PEVOPLASTIC®  
PEVOTHA®

Solid rubber  
wheels and castors

Electrically conductive  
wheels and castors

VULKOLLAN® • PEVOPIK®  
PEVODYN® / -Soft

Stainless steel castors

Institutional  
wheels and castors

Conveyor/guiding  
rollers and ball units

Profile rollers

Pallet rollers









Press-on tyres

# Solid rubber industrial castors











Series 32/3

Series 31/3

								
Article code	mm	mm	mm	mm	mm	mm	mm	kg
31/080/25/3 L	80	25	108	105 x 85	80 x 60	9	38	50
31/100/30/3 L	100	30	128	105 x 85	80 x 60	9	38	70
31/125/37/3 L	125	37	155	105 x 85	80 x 60	9	45	100
31/125/37/3	125	38	164	135 x 110	105 x 80	11	55	100
31/160/40/3	160	40	199	135 x 110	105 x 80	11	55	135
31/180/45/3	180	45	219	135 x 110	105 x 80	11	55	170
31/200/50/3	200	50	239	135 x 110	105 x 80	11	55	205
31/250/60/3	250	58	290	135 x 110	105 x 80	11	55	295

## Industrial swivel castors with solid rubber wheels in standard quality

Wheels series 80 with roller bearing (/3), see page 60.

							
Article code	mm	mm	mm	mm	mm	mm	kg
32/080/25/3 L	80	25	108	105 x 85	80 x 60	9	50
32/100/30/3 L	100	30	128	105 x 85	80 x 60	9	70
32/125/37/3 L	125	37	155	105 x 85	80 x 60	9	100
32/125/37/3	125	38	164	135 x 110	105 x 80	11	100
32/160/40/3	160	40	199	135 x 110	105 x 80	11	135
32/180/45/3	180	45	219	135 x 110	105 x 80	11	170
32/200/50/3	200	50	239	135 x 110	105 x 80	11	205
32/250/60/3	250	58	290	135 x 110	105 x 80	11	295

1-way directional lock only available for plate 135 x 110 mm.

## Industrial fixed castors

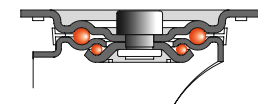

## Industrial swivel castor brackets with a load capacity of up to 295 kg

Housings made of pressed steel, zinc and chromated. Swivel head with double ball bearings, dust and splash proof, with riveted kingpin. ALLSTOP total locking device on the trailing side of the housing, blocks rolling and swivel motion simultaneously.

\* with ALLSTOP total locking device code: 31 FZ/..

**ALLSTOP total locking device**  
Code: 31 F/...



**directional lock**  
Code: 31/...1RIF



**single bolt hole**  
Code: 31/...R



**foot protection**  
Code: ...PRO



**single bolt hole/total lock**  
Code: 31 F/...R



**stem fitting**  
Code: 31 Z/...\*



# Solid rubber industrial castors



Series 32 HE/3

Series 31 HE/3

								
Article code	mm	mm	mm	mm	mm	mm	mm	kg
31 HE/100/30/3 L	100	30	128	105 x 85	80 x 60	9	45	100
31 HE/125/37/3 L	125	37	155	105 x 85	80 x 60	9	45	120
31 HE/125/37/3	125	37	164	135 x 110	105 x 80	11	55	145
31 HE/160/40/3	160	40	199	135 x 110	105 x 80	11	55	225
31 HE/180/45/3	180	45	219	135 x 110	105 x 80	11	55	300
31 HE/200/50/3	200	50	239	135 x 110	105 x 80	11	55	350

## Industrial swivel castors with ELASTIC solid rubber wheels

Wheels series 80 HE with roller bearing (/3), see page 60.

							
Article code	mm	mm	mm	mm	mm	mm	kg
32 HE/100/30/3 L	100	30	128	105 x 85	80 x 60	9	100
32 HE/125/37/3 L	125	37	155	105 x 85	80 x 60	9	120
32 HE/125/37/3	125	37	164	135 x 110	105 x 80	11	145
32 HE/160/40/3	160	40	199	135 x 110	105 x 80	11	225
32 HE/180/45/3	180	45	219	135 x 110	105 x 80	11	300
32 HE/200/50/3	200	50	239	135 x 110	105 x 80	11	350

1-way directional lock not available for plate 105 x 85 mm.

## Industrial fixed castors

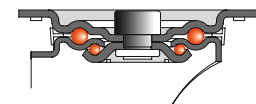

## Industrial swivel castor brackets with a load capacity of up to 350 kg

Housings made of pressed steel, zinc and chromated. Swivel head with double ball bearings, dust and splash proof, with riveted kingpin. ALLSTOP total locking device on the trailing side of the housing, blocks rolling and swivel motion simultaneously.

\* with ALLSTOP total locking device code: 31 FZ HE/..

<b>ALLSTOP total locking device</b> Code: 31 F HE/...	<b>single bolt hole</b> Code: 31 HE/...R	<b>single bolt hole/total lock</b> Code: 31 F HE/...R
		
<b>directional lock</b> Code: 31 HE/...TRIF	<b>foot protection</b> Code: ...PRO	<b>stem fitting</b> Code: 31 Z HE/...*
		

PEVOLOUP® • PEVOLOUP®  
PEVOTHA®

Solid rubber wheels and castors

Electrically conductive wheels and castors

VULKOLLAN® • PEVOLOUP®  
PEVOLOUP® / -Soft

Stainless steel castors

Industrial wheels and castors

Conveyor/guiding rollers and ball units

Profile rollers

Roller rollers

Press-on tyres

# Solid rubber industrial castors



Series 32 PS

Series 31 PS

Article code	mm	mm	mm	mm	mm	mm	mm	kg
31 PS/080/35/1 L	80	35	108	105 x 85	80 x 60	9	38	80
31 PS/100/34/1 L	100	34	128	105 x 85	80 x 60	9	38	100
31 PS/125/37/1 L	125	37	155	105 x 85	80 x 60	9	45	120
31 PS/150/45/1	150	45	194	135 x 110	105 x 80	11	55	180
31 PS/200/50/1	200	50	239	135 x 110	105 x 80	11	55	300
31 PS/080/35/3 L	80	35	108	105 x 85	80 x 60	9	38	80
31 PS/100/34/3 L	100	34	128	105 x 85	80 x 60	9	38	100
31 PS/125/37/3 L	125	37	155	105 x 85	80 x 60	9	45	120
31 PS/160/50/3	160	50	199	135 x 110	105 x 80	11	55	200
31 PS/200/50/3	200	50	239	135 x 110	105 x 80	11	55	300

## Industrial swivel castors with thermoplastic rubber wheels, non-marking

Wheels series 89 PS with plain bearing (1) or roller bearing (3), see page 61.

Article code	mm	mm	mm	mm	mm	mm	kg
32 PS/080/35/1 L	80	35	108	105 x 85	80 x 60	9	80
32 PS/100/34/1 L	100	34	128	105 x 85	80 x 60	9	100
32 PS/125/37/1 L	125	37	155	105 x 85	80 x 60	9	120
32 PS/150/45/1	150	45	194	135 x 110	105 x 80	11	180
32 PS/200/50/1	200	50	239	135 x 110	105 x 80	11	300
32 PS/080/35/3 L	80	35	108	105 x 85	80 x 60	9	80
32 PS/100/34/3 L	100	34	128	105 x 85	80 x 60	9	100
32 PS/125/37/3 L	125	37	155	105 x 85	80 x 60	9	120
32 PS/160/50/3	160	50	199	135 x 110	105 x 80	11	200
32 PS/200/50/3	200	50	239	135 x 110	105 x 80	11	300

## Industrial fixed castors

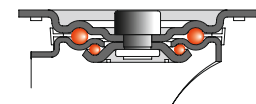

## Industrial swivel castor brackets with a load capacity of up to 300 kg

Housings made of pressed steel, zinc and chromated. Swivel head with double ball bearings, dust and splash proof, with riveted kingpin. ALLSTOP total locking device on the trailing side of the housing, blocks rolling and swivel motion simultaneously.

**ALLSTOP total locking device**  
Code: 31 F PS/...

**foot protection**  
Code: ...PRO

**single bolt hole**  
Code: 31 PS/...R

**stem fitting**  
Code: 31 Z PS/...

**single bolt hole/total lock**  
Code: 31 F PS/...R

**stem fitting/total locking device**  
Code: 31 FZ PS/...

PEVOLOP® - PEVOLOSTIC®  
PEVOTHA®  
Solid rubber wheels and castors  
Electrically conductive wheels and castors  
VULKOLLAN® - PEVOPIUR® PEVODIN® - Soft  
Stainless steel castors  
Institutional wheels and castors  
Conveyor/guiding rollers and ball units  
Profile rollers  
Pallet rollers  
Press-on tyres

# Solid rubber industrial castors



Series 28 Stage

Series 27 Stage

Article code	mm	mm	mm	mm	mm	mm	mm	kg
27 STAGE/080/34/3 L	80	34	101	105 x 80	80 x 60	9	36	150
27 STAGE/100/36/3 L	100	36	125	105 x 80	80 x 60	9	36	200
27 STAGE/125/36/3 L	125	36	155	105 x 80	80 x 60	9	36	250
27 STAGE/160/50/3	160	50	199	135 x 110	105 x 80	11	55	300

## Industrial swivel castors with ELASTIC solid rubber wheels (Blue Wheel)

Wheels series 74 with roller bearing (1/3), see page 62.

Article code	mm	mm	mm	mm	mm	mm	kg
28 STAGE/080/34/3 L	80	34	101	102 x 87	80 x 60	9	150
28 STAGE/100/36/3 L	100	36	125	102 x 87	80 x 60	9	200
28 STAGE/125/36/3 L	125	36	155	102 x 87	80 x 60	9	250
28 STAGE/160/50/3	160	50	199	135 x 110	105 x 80	11	300

## Industrial fixed castors

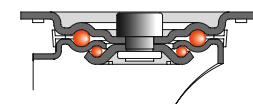

## Industrial swivel castor brackets with a load capacity of up to 300 kg

Housings made of pressed steel, zinc and chromated. Swivel head with double ball bearings, dust and splash proof, with riveted kingpin. ALLSTOP total locking device on the trailing side of the housing, blocks rolling and swivel motion simultaneously.

ALLSTOP total locking device  
Code: 27 F STAGE/...

single bolt hole  
Code: 27 STAGE/...R

single bolt hole/total lock  
Code: 27 F STAGE/...R

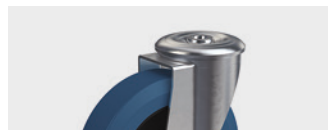

# Solid rubber industrial castors



Series 22

Series 21

Article code	mm	mm	mm	mm	mm	mm	mm	kg
21/100/32/3 L	100	32	128	105 x 85	80 x 60	9	45	140
21/125/40/3	125	40	164	135 x 110	105 x 80	11	55	180
21/160/50/3	160	50	199	135 x 110	105 x 80	11	55	300
21/200/50/3	200	50	239	135 x 110	105 x 80	11	55	400
21/125/40/5	125	40	164	135 x 110	105 x 80	11	55	180
21/160/50/5	160	50	199	135 x 110	105 x 80	11	55	300
21/200/50/5	200	50	239	135 x 110	105 x 80	11	55	400
21/250/50/5	250	50	290	135 x 110	105 x 80	11	55	400

## Industrial swivel castors with ELASTIC solid rubber wheels

Wheels series 76 with roller bearing (1/3) or ball bearings (1/5), see page 62.

Article code	mm	mm	mm	mm	mm	mm	kg
22/100/32/3 L	100	32	128	105 x 85	80 x 60	9	140
22/125/40/3	125	40	164	135 x 110	105 x 80	11	180
22/160/50/3	160	50	199	135 x 110	105 x 80	11	300
22/200/50/3	200	50	239	135 x 110	105 x 80	11	400
22/125/40/5	125	40	164	135 x 110	105 x 80	11	180
22/160/50/5	160	50	199	135 x 110	105 x 80	11	300
22/200/50/5	200	50	239	135 x 110	105 x 80	11	400
22/250/50/5	250	50	290	135 x 110	105 x 80	11	400

1-way directional lock not available for plate 105 x 85 mm.

## Industrial fixed castors

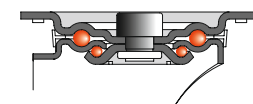

## Industrial swivel castor brackets with a load capacity of up to 400 kg

Housings made of pressed steel, zinc and chromated. Swivel head with double ball bearings, dust and splash proof, with riveted kingpin. ALLSTOP total locking device on the trailing side of the housing, blocks rolling and swivel motion simultaneously.

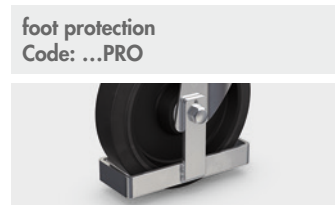
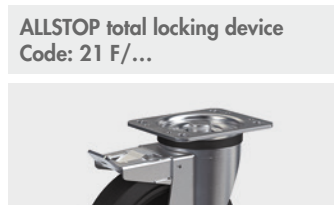

PEVOLOP® - PEVOPLASTIC®  
PEVOTHA®  
Solid rubber wheels and castors  
Electrically conductive wheels and castors  
VULKOLLAN® - PEVOPLUR® PEVOVIM® - Soft  
Stainless steel castors  
Institutional wheels and castors  
Conveyor/guiding rollers and ball units  
Profile rollers  
Pallet rollers  
Press-on tyres









# Solid rubber industrial castors











Series 24

Series 23

								
Article code	mm	mm	mm	mm	mm	mm	mm	kg
23/100/40/5 GH	100	40	140	135 x 110	105 x 80	11	55	160
23/125/50/5	125	50	164	135 x 110	105 x 80	11	55	225
23/160/50/5	160	50	199	135 x 110	105 x 80	11	55	300
23/200/50/5	200	50	239	135 x 110	105 x 80	11	55	400
23/250/50/5	250	50	290	135 x 110	105 x 80	11	55	400

## Industrial swivel castors with ELASTIC solid rubber wheels

Wheels series 73 with ball bearings (/5), see page 63.

							
Article code	mm	mm	mm	mm	mm	mm	kg
24/100/40/5 GH	100	40	140	135 x 110	105 x 80	11	160
24/125/50/5	125	50	164	135 x 110	105 x 80	11	225
24/160/50/5	160	50	199	135 x 110	105 x 80	11	300
24/200/50/5	200	50	239	135 x 110	105 x 80	11	400
24/250/50/5	250	50	290	135 x 110	105 x 80	11	400

## Industrial fixed castors

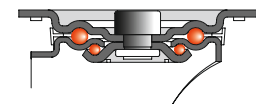

## Industrial swivel castor brackets with a load capacity of up to 400 kg

Housings made of pressed steel, zinc plated and chromated. Swivel head with double ball bearings, dust and splash proof, with riveted kingpin. ALLSTOP total locking device on the trailing side of the housing, blocks rolling and swivel motion simultaneously.

**ALLSTOP total locking device**  
Code: 23 F/...



**directional lock**  
Code: 23/...TRIF



**foot protection**  
Code: ...PRO

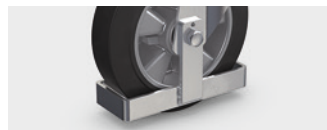









# Solid rubber industrial castors











Series 26

Series 25

								
Article code	mm	mm	mm	mm	mm	mm	mm	kg
25/100/40/5 L	100	40	140	105 x 85	80 x 60	9	45	160
25/100/40/5	100	40	148	135 x 110	105 x 80	11	50	160
25/125/40/5 L	125	40	165	105 x 85	80 x 60	9	45	225
25/125/50/5	125	50	178	135 x 110	105 x 80	11	50	225
25/160/50/5	160	50	210	135 x 110	105 x 80	11	50	300
25/200/50/5	200	50	250	135 x 110	105 x 80	11	55	400
25/300/60/5	300	60	347	200 x 160	160 x 120	15	73	700

## Industrial swivel castors with ELASTIC solid rubber wheels

Wheels series 73 with ball bearings (/5), see page 63.

							
Article code	mm	mm	mm	mm	mm	mm	kg
26/100/40/5 L	100	40	140	105 x 85	80 x 60	9	160
26/100/40/5	100	40	148	135 x 110	105 x 80	11	160
26/125/40/5 L	125	40	165	105 x 85	80 x 60	9	225
26/125/50/5	125	50	178	135 x 110	105 x 80	11	225
26/160/50/5	160	50	210	135 x 110	105 x 80	11	300
26/200/50/5	200	50	250	135 x 110	105 x 80	11	400
26/300/60/5	300	60	347	200 x 160	160 x 120	15	700

## Industrial fixed castors

4-way directional lock not available for plate 200 x 160 mm.

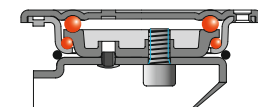

## Industrial swivel castor brackets with a load capacity of up to 700 kg

Housings made of pressed steel, zinc and chromated. Swivel head with double ball bearings, dust and splash proof. Without kingpin. With grease nipple. ALLSTOP total locking device on the trailing side of the housing, blocks rolling and swivel motion simultaneously.

ALLSTOP total locking device  
Code: 25 F/...\*



4-way directional lock  
Code: 25/...4RIF



wheel and directional lock  
Code: 25 RF/...4RIF



foot protection  
Code: ...PRO



\* Plate 200 x 160 mm with ALLSTOP total locking device on the non-trailing side of the housing.









PEVOLOP® - PEVOPLASTIC®  
PEVODIN® - Soft  
Solid rubber wheels and castors  
Electrically conductive wheels and castors  
VULKOLLAN® - PEVOPLUR®  
PEVODIN® / -Soft  
Stainless steel castors  
Institutional wheels and castors  
Conveyor/guiding rollers and ball units  
Profile rollers  
Pallet rollers  
Press-on tyres

# Pneumatic tyred industrial castors











Series 40

Series 39

								
Article code	mm	mm	mm	mm	mm	mm	mm	kg
39/180/045/3 R	180	45	219	135 x 110	105 x 80	11	55	75
39/200/050/3 R	200	50	239	135 x 110	105 x 80	11	55	75
39/210/065/3 R	210	65	245	135 x 110	105 x 80	11	60	100
39/220/070/3 S	220	70	255	135 x 110	105 x 80	11	61	135
39/260/085/3 S	260	85	310	200 x 160	160 x 120	14	90	250
39/150/030/5 R	150	30	188	90 x 70	75 x 45	9	50	50
39/210/065/5 R	210	65	245	135 x 110	105 x 80	11	62	80
39/220/060/5 S	220	60	248	140 x 110	105 x 80	11	55	135
39/260/085/5 S	260	85	295	175 x 175	140 x 140	14	70	250

## Industrial swivel castors with pneumatic tyred wheels

Wheels series 91 with rib (R) or block (S) profile and roller bearing (/3) or ball bearings (/5), see page 66.

							
Article code	mm	mm	mm	mm	mm	mm	kg
40/180/045/3 R	180	45	219	135 x 110	105 x 80	11	75
40/200/050/3 R	200	50	239	135 x 110	105 x 80	11	75
40/210/065/3 R	210	65	245	135 x 110	105 x 80	11	100
40/220/070/3 S	220	70	255	135 x 110	105 x 80	11	135
40/260/085/3 S	260	85	310	200 x 160	160 x 120	14	200
40/150/030/5 R	150	30	188	90 x 70	75 x 45	9	50
40/210/065/5 R	210	65	245	137 x 114	105 x 80	11	100
40/220/060/5 S	220	60	248	140 x 110	105 x 80	11	135
40/260/085/5 S	260	85	295	230 x 125	190 x 75	14	250

## Industrial fixed castors

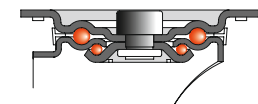

## Industrial swivel castor brackets with a load capacity of up to 250 kg

Housings made of pressed steel, zinc and chromated. Swivel head with double ball bearings, dust and splash proof, with riveted kingpin. Standard type with top plate.









Design with locking device or bolt hole housing available on request.

# Solid rubber heavy-duty castors











Series 2 B

Series 1 B

									
Article code	mm	mm	mm	mm	mm	mm	mm	mm	kg
1 B/160/50/5	160	50	205	140 x 110	105 x 80	13	55	350	
1 B/200/50/5	200	50	245	140 x 110	105 x 80	13	60	400	
1 B/250/60/5	250	60	305	175 x 140	140 x 105	15	75	500	
1 B/250/80/5	250	80	305	175 x 140	140 x 105	15	75	700	
1 B/300/75/5	300	75	355	175 x 140	140 x 105	15	85	800	

## Heavy-duty swivel castors with ELASTIC solid rubber wheels

Wheels series 83 ST with ball bearings (1/5), see page 63.

								
Article code	mm	mm	mm	mm	mm	mm	mm	kg
2 B/160/50/5	160	50	205	140 x 110	105 x 80	13	350	
2 B/200/50/5	200	50	245	140 x 110	105 x 80	13	400	
2 B/250/60/5	250	60	305	175 x 140	140 x 105	15	500	
2 B/250/80/5	250	80	305	175 x 140	140 x 105	15	700	
2 B/300/75/5	300	75	355	175 x 140	140 x 105	15	800	

## Heavy-duty fixed castors

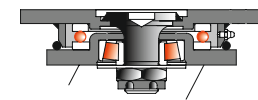

## Precision heavy-duty swivel castor brackets with a load capacity of up to 800 kg

Housings in precise highly stable welded steel construction. Swivel head with a high quality thrust ball bearing and a tapered roller bearing for the guidance of the kingpin. All bearing parts dust and splash proof. ALLSTOP total locking device on the non-trailing side of the housing, blocks rolling and swivel motion simultaneously.

ALLSTOP total locking device  
Code: 1 BF/...



4-way directional lock  
Code: 1 B/...4RIF



wheel and directional lock  
Code: 1 BF/...4RIF



foot protection  
Code: ...PRO



# PE·VO·LON® / PE·VO·THAN®

## electrically conductive wheels and castors



PEVOLON® - PEVOLOSTIC®  
PEVOTHAN®

Solid rubber  
wheels and castors

Electrically conductive  
wheels and castors

VULKOLLAN® - PEVOPUR®  
PEVODYN® / -Soft

Stainless steel castors

Institutional  
wheels and castors

Conveyor/guiding  
rollers and ball units

Profile rollers

Pallet rollers

Press-on tyres

# PE·VO·LON® / PE·VO·THAN®

## electrically conductive product overview

### Electrically conductive WHEELS AND CASTORS

Electrically conductive PEVOLON® is a thermoplastic material based on polyamide.

This wheel material has high load capacity, good abrasion resistance and a low friction coefficient. Electrically conductive PEVOTHAN® is a high-quality thermoplastically processed polyurethane (TPU) elastomer with high abrasion resistance and very good damping power.

Electrically conductive PEVOLON® and electrically conductive PEVOTHAN® are completely non-marking and have good chemical resistance. In accordance with the European standard DIN EN 12527 ff., the electrical volume resistance is less than  $10^4$  (10,000) ohms.



Series 85 XPU  
Series 89 XPU  
60 - 225 kg  
[Page 80](#)

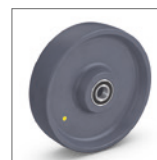

Series AX  
Series 87 XPU  
300 - 1.000 kg  
[Page 81](#)



Series 67 XPU  
Series 68 XPU  
60 - 125 kg  
[Page 83](#)



Series 31 XPU  
Series 32 XPU  
100 - 225 kg  
[Page 84](#)



Series 51 XPU  
Series 52 XPU  
120 - 400 kg  
[Page 85](#)



Series WLX/WBX  
250 - 750 kg  
[Page 86](#)



Series 67 XPU NI  
Series 68 XPU NI  
60 - 125 kg  
[Page 87](#)



Series 31 XPU NI  
Series 32 XPU NI  
100 - 225 kg  
[Page 88](#)



Series WLX NI  
Series WBX NI  
250 - 750 kg  
[Page 89](#)





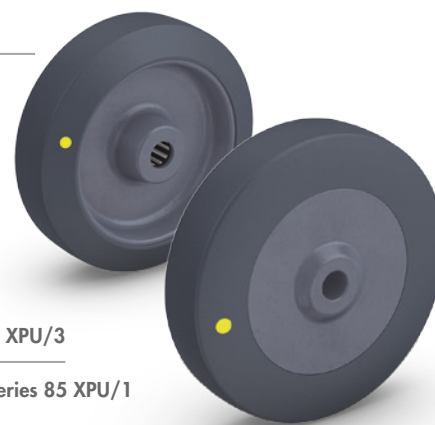

# PE·VO·THAN®

## electrically conductive wheels









Series 89 XPU/3

Series 85 XPU/1

 Article code	 mm	 mm	 mm	 mm	 kg
85 XPU/075/024/1/08	75	24	28	08	60
85 XPU/075/024/1/10	75	24	28	10	60
85 XPU/100/030/1/12	100	30	39	12	100
85 XPU/125/030/1/12	125	30	39	12	125

### Electrically conductive PEVOTHAN® wheels

Electrically conductive PEVOLON® rim with a tread made of high-quality thermoplastic polyurethane (80° Shore A), with plain bearing (/1).

 Article code	 mm	 mm	 mm	 mm	 kg
89 XPU/080/035/3/10	80	35	40	26	100
89 XPU/100/034/3/10	100	34	40	26	140
89 XPU/125/037/3/15	125	37	47	32	180
89 XPU/150/045/3/15	150	45	50	35	225

### Electrically conductive PEVOTHAN® wheels

Electrically conductive PEVOLON® rim with a tread made of high-quality thermoplastic polyurethane (80° Shore A), with roller bearing (/3) or stainless roller bearing (/3R).

89 XPU/080/035/3R/10	80	35	40	26	10	100
89 XPU/100/034/3R/10	100	34	40	26	10	140
89 XPU/125/037/3R/15	125	37	47	32	15	180
89 XPU/150/045/3R/15	150	45	50	35	15	225

PEVOLON® • PEVOLASTIC®  
PEVOTHAN®

Solid rubber  
wheels and castors

Electrically conductive  
wheels and castors

VULVOLAN® • PEVOPUR®  
PEVODIN® • Soft

Stainless steel castors

Institutional  
wheels and castors

Conveyor/guiding  
rollers and ball units

Profile rollers

Pallet rollers

Press-on tyres

# PE·VO·THAN®/PE·VO·LON®

## electrically conductive wheels

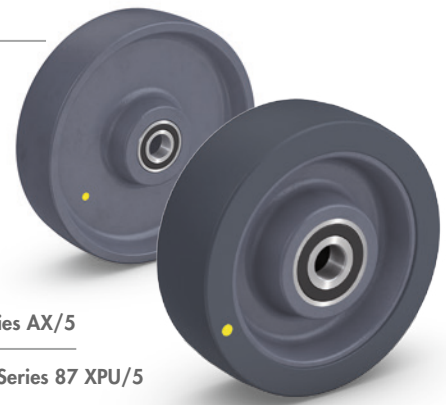







Series AX/5

Series 87 XPU/5

Article code	 mm	 mm	 mm	 mm	 mm	 mm	 kg
87 XPU/080/035/5/12	80	35	31	31	41	12	110
87 XPU/100/040/5/15	100	40	45	41	45	15	160
87 XPU/125/045/5/15	125	45	45	41	45	15	250
87 XPU/150/050/5/20	150	50	55	58	65	20	280
87 XPU/160/050/5/20	160	50	55	51	65	20	300
87 XPU/200/050/5/20	200	50	55	51	60	20	400

87 XPU/080/035/5R/12	80	35	31	31	40	12	110
87 XPU/100/040/5R/15	100	40	45	41	45	15	160
87 XPU/125/045/5R/15	125	45	45	41	45	15	250
87 XPU/150/050/5R/20	150	50	55	58	65	20	280
87 XPU/160/050/5R/20	160	50	55	51	65	20	300
87 XPU/200/050/5R/20	200	50	55	51	60	20	400

Article code	 mm	 mm	 mm	 mm	 mm	 mm	 kg
AX 080/035/5/12	80	35	35	33	50	12	300
AX 100/040/5/15	100	40	45	41	48	15	450
AX 125/040/5/20	125	40	53	53	60	20	600
AX 150/050/5/20	150	50	55	53	65	20	600
AX 200/050/5/20	200	50	55	53	65	20	1.000

AX 080/035/5R/12	80	35	35	33	50	12	300
AX 100/040/5R/15	100	40	45	41	48	15	450
AX 125/040/5R/20	125	40	53	53	60	20	600
AX 150/050/5R/20	150	50	55	53	65	20	600
AX 200/050/5R/20	200	50	55	54	65	20	1.000

### Electrically conductive PEVOTHAN® wheels

Electrically conductive PEVOLON® rim with a tread made of high-quality thermoplastic polyurethane (96° Shore A), with ball bearings (/5) or stainless ball bearings (/5R).

### Electrically conductive PEVOLON® wheels with ball bearings

High-quality thermoplastic polyamid. Wheels in heavy-duty design with ball bearings (/5) or stainless ball bearings (/5R).

PEVOLON® - PEVOLOSTIC®  
PEVOTHAN®

Solid rubber  
wheels and castors

Electrically conductive  
wheels and castors

VULVOLAN® - PEVOPIUR®  
PEVODIV® - Soft

Stainless steel castors

Institutional  
wheels and castors

Conveyor/guiding  
rollers and ball units

Profile rollers

Pallet rollers

Press-on tyres



# Electrically conductive castors



Press-on tyres

Pallet rollers

Profile rollers

Conveyor/guiding rollers and ball units

Institutional wheels and castors

Stainless steel castors

VULKOLLAN® • PEVOPLUR® PEVOVYN® / -Soft

Electrically conductive wheels and castors

Solid rubber wheels and castors

PEVOLON® • PEVOPLASTIC® PEVOHAN®

# PE·VO·THAN® electrically conductive institutional castors

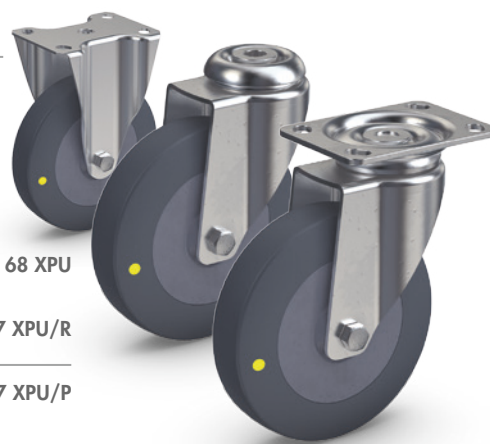

Series 68 XPU

Series 67 XPU/R

Series 67 XPU/P

Article code	mm	mm	mm	mm	mm	mm	mm	mm	kg
67 XPU/075/24/1/P	75	24	100	60 x 60	48 x 48/38 x 38	6	-	30	60
67 XPU/100/30/1/P	100	30	135	95 x 70	76 x 52/72 x 45	9	-	41	100
67 XPU/125/30/1/P	125	30	160	95 x 70	76 x 52/72 x 45	9	-	39	125
67 XPU/075/24/1/R	75	24	98	-	-	-	10	30	60
67 XPU/100/30/1/R	100	30	132	-	-	-	12	41	100
67 XPU/125/30/1/R	125	30	160	-	-	-	12	39	125

Fixing devices for institutional swivel castors with bolt hole fitting, see page 133.

Article code	mm	mm	mm	mm	mm	mm	kg
68 XPU/075/24/1/P	75	24	100	67 x 60	48 x 48/38 x 38	6	60
68 XPU/100/30/1/P	100	30	135	95 x 70	76 x 52/72 x 45	9	100
68 XPU/125/30/1/P	125	30	160	95 x 70	76 x 52/72 x 45	9	125

## Institutional swivel castors with electrically conductive PEVO THAN® wheels

Wheels series 85 XPU (80° Shore A) with plain bearing (/1), see page 80.

## Institutional fixed castors

Matching the swivel castors with top plate (/P).

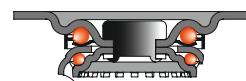

## Institutional swivel castor brackets with a load capacity of up to 125 kg

Housings made of pressed steel, zinc and chromated. Swivel head with double ball bearings and riveted kingpin. ALLSTOP total locking device on the trailing side of the housing, blocks rolling and swivel motion simultaneously.

ALLSTOP total locking device  
Code: 67 F XPU/.../P

single bolt hole/total lock  
Code: 67 F XPU/...R



PEVOLAN® - PEVOPLASTIC®  
PEVO THAN®

Solid rubber wheels and castors

Electrically conductive wheels and castors

VULKOLLAN® - PEVOPLUR®  
PEVOVIM® - Soft

Stainless steel castors

Institutional wheels and castors

Conveyor/guiding rollers and ball units

Profile rollers

Roller rollers









Press-on tyres

# PE·VO·THAN® electrically conductive industrial castors











Series 32 XPU/3

Series 31 XPU/3

								
Article code	mm	mm	mm	mm	mm	mm	mm	kg
31 XPU/080/35/3 L	80	35	108	105 x 85	80 x 60	9	38	100
31 XPU/100/34/3 L	100	34	128	105 x 85	80 x 60	9	38	140
31 XPU/125/37/3 L	125	37	155	105 x 85	80 x 60	9	45	180
31 XPU/150/45/3	150	45	194	135 x 110	105 x 80	11	55	225

## Industrial swivel castors with electrically conductive PEVOTHAN® wheels

Wheels series 89 XPU (80° Shore A) with roller bearing (/3), see page 80.

							
Article code	mm	mm	mm	mm	mm	mm	kg
32 XPU/080/35/3 L	80	35	108	105 x 85	80 x 60	9	100
32 XPU/100/34/3 L	100	34	128	105 x 85	80 x 60	9	140
32 XPU/125/37/3 L	125	37	155	105 x 85	80 x 60	9	180
32 XPU/150/45/3	150	45	194	135 x 110	105 x 80	11	225

## Industrial fixed castors

**ALLSTOP total locking device**  
Code: 31 F XPU/...



**single bolt hole**  
Code: 31 XPU/...R



**single bolt hole/total lock**  
Code: 31 F XPU/...R



**foot protection**  
Code: ...PRO

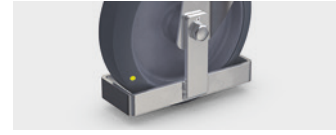

**stem fitting**  
Code: 31 Z XPU/...



**stem fitting/total locking device**  
Code: 31 FZ XPU/...



## Industrial swivel castor brackets with a load capacity of up to 225 kg

Housings made of pressed steel, zinc and chromated. Swivel head with double ball bearings, dust and splash proof, with riveted kingpin. ALLSTOP total locking device on the trailing side of the housing, blocks rolling and swivel motion simultaneously.

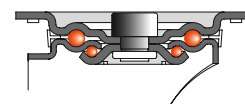

# PE·VO·THAN® electrically conductive industrial castors



Series 52 XPU/5

Series 51 XPU/5

								
Article code	mm	mm	mm	mm	mm	mm	mm	kg
51 XPU/080/35/5 L	80	35	108	105 x 85	80 x 60	9	38	120
51 XPU/100/40/5 GH	100	40	140	135 x 110	105 x 80	11	55	200
51 XPU/125/45/5	125	45	164	135 x 110	105 x 80	11	55	250
51 XPU/160/50/5	160	50	199	135 x 110	105 x 80	11	55	300
51 XPU/200/50/5	200	50	239	135 x 110	105 x 80	11	55	400

## Industrial swivel castors with electrically conductive PEVOTHAN® wheels

Wheels series 87 XPU (96° Shore A) with ball bearings (/5), see page 81.

							
Article code	mm	mm	mm	mm	mm	mm	kg
52 XPU/080/35/5 L	80	35	108	105 x 85	80 x 60	9	120
52 XPU/100/40/5 GH	100	40	140	135 x 110	105 x 80	11	200
52 XPU/125/45/5	125	45	164	135 x 110	105 x 80	11	250
52 XPU/160/50/5	160	50	199	135 x 110	105 x 80	11	300
52 XPU/200/50/5	200	50	239	135 x 110	105 x 80	11	400

## Industrial fixed castors

1-way directional lock not available for plate 105 x 85 mm.

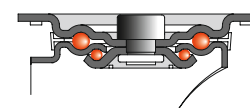

## Industrial swivel castor brackets with a load capacity of up to 400 kg

Housings made of pressed steel, zinc and chromated. Swivel head with double ball bearings, dust and splash proof, with riveted kingpin. ALLSTOP total locking device on the trailing side of the housing, blocks rolling and swivel motion simultaneously.

\* with locking device code: 51 FZ XPU/...

ALLSTOP total locking device  
Code: 51 F XPU/...



single bolt hole  
Code: 51 XPU/...R



single bolt hole/total lock  
Code: 51 F XPU/...R



directional lock  
Code: 51 XPU/...1RIF



foot protection  
Code: ...PRO

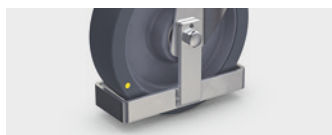

stem fitting  
Code: 51 Z XPU/...\*



PEVOPUR® - PEVOPUR®  
PEVOTHAN®

Solid rubber  
wheels and castors

Electrically conductive  
wheels and castors

VULVOLIAN® - PEVOPUR®  
PEVOTHAN® - Soft

Stainless steel castors

Institutional  
wheels and castors

Conveyor/guiding  
rollers and ball units

Profile rollers

Pallet rollers

Press-on tyres

# PE·VO·LON® electrically conductive industrial castors



Series WBX/5

Series WLX/5

Article code	mm	mm	mm	mm	mm	mm	mm	kg
WLX 080/35/5 L	80	35	118	105 x 85	80 x 60	9	40	250
WLX 100/40/5 L	100	40	140	105 x 85	80 x 60	9	45	350
WLX 125/40/5	125	40	178	135 x 110	105 x 80	11	50	600
WLX 150/50/5	150	50	205	135 x 110	105 x 80	11	50	600
WLX 200/50/5	200	50	250	135 x 110	105 x 80	11	55	750

## Heavy-duty industrial swivel castors with electrically conductive PEVOLON® wheels

Wheels series AX with ball bearings (/5), see page 81.

Article code	mm	mm	mm	mm	mm	mm	kg
WBX 080/35/5 L	80	35	118	105 x 85	80 x 60	9	250
WBX 100/40/5 L	100	40	140	105 x 85	80 x 60	9	350
WBX 125/40/5	125	40	178	135 x 110	105 x 80	11	600
WBX 150/50/5	150	50	205	135 x 110	105 x 80	11	600
WBX 200/50/5	200	50	250	135 x 110	105 x 80	11	750

## Heavy-duty industrial fixed castors

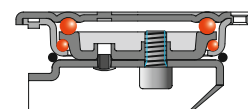

## Industrial swivel castor brackets with a load capacity of up to 750 kg

Housings made of strong pressed steel, zinc and chromated. Swivel head with double ball bearings, dust and splash proof. Without kingpin. With grease nipple. ALLSTOP total locking device on the trailing side of the housing, blocks rolling and swivel motion simultaneously.

ALLSTOP total locking device  
Code: WLFX...



4-way directional lock  
Code: WLX...4RIF



wheel and directional lock  
Code: WLFX...4RIF



foot protection  
Code: ...PRO



# PE·VO·THAN® electrically conductive industrial castors



Series 68 XPU NI

Series 67 XPU NI/R

Series 67 XPU NI/P

Article code	mm	mm	mm	mm	mm	mm	mm	mm	kg
67 XPU NI/075/24/1/P	75	24	107	95 x 70	75 x 45/72 x 52	8	-	33	60
67 XPU NI/100/30/1/P	100	30	135	95 x 70	75 x 45/72 x 52	8	-	41	100
67 XPU NI/125/30/1/P	125	30	161	95 x 70	75 x 45/72 x 52	8	-	39	125
67 XPU NI/075/24/1/R	75	24	98	-	-	-	10	30	60
67 XPU NI/100/30/1/R	100	30	132	-	-	-	12	41	100
67 XPU NI/125/30/1/R	125	30	160	-	-	-	12	39	125

Fixing devices for institutional swivel castors with bolt hole fitting, see page 127.

Article code	mm	mm	mm	mm	mm	mm	kg
68 XPU NI/075/24/1/P	75	24	107	95 x 77	75 x 45/72 x 52	8	60
68 XPU NI/100/30/1/P	100	30	135	95 x 77	75 x 45/72 x 52	8	100
68 XPU NI/125/30/1/P	125	30	161	95 x 77	75 x 45/72 x 52	8	125

## Stainless steel institutional swivel castors with electrically conductive PEVOTHAN® wheels

Wheels series 85 XPU (80° Shore A) with plain bearing (/1), see page 80.

## Stainless steel institutional fixed castors

Matching the swivel castors with top plate (/P).

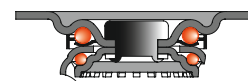

## Institutional swivel castor brackets with a load capacity of up to 125 kg

Housings made of stainless pressed steel. Swivel head with double ball bearing and riveted kingpin. ALLSTOP total locking device on the trailing side of the housing, blocks rolling and swivel motion simultaneously.

ALLSTOP total locking device  
Code: 67 F XPU NI/.../P

single bolt hole/total lock  
Code: 67 F XPU NI/.../R











# PE·VO·THAN® electrically conductive stainless steel industrial castors











Series 32 XPU NI/3R

Series 31 XPU NI/3R

Article code	 mm	 mm	 mm	 mm	 mm	 mm	 mm	 kg
31 XPU NI/080/35/3R L	80	35	108	105 x 85	80 x 60	9	38	100
31 XPU NI/100/34/3R L	100	34	128	105 x 85	80 x 60	9	38	140
31 XPU NI/125/37/3R L	125	37	155	105 x 85	80 x 60	9	45	180
31 XPU NI/150/45/3R	150	45	192	135 x 110	105 x 80	11	55	225

## Stainless steel industrial swivel castors with electrically conductive PEVOTHAN® wheels

Wheels series 89 XPU (80° Shore A) with stainless roller bearing (/3R), see page 80.

Article code	 mm	 mm	 mm	 mm	 mm	 mm	 mm	 kg
32 XPU NI/080/35/3R L	80	35	108	105 x 85	80 x 60	9	38	100
32 XPU NI/100/34/3R L	100	34	128	105 x 85	80 x 60	9	38	140
32 XPU NI/125/37/3R L	125	37	155	105 x 85	80 x 60	9	45	180
32 XPU NI/150/45/3R	150	45	192	135 x 110	105 x 80	11	55	225

## Stainless steel industrial fixed castors

ALLSTOP total locking device  
Code: 31 F XPU NI/...



single bolt hole  
Code: 31 XPU NI/...R



single bolt hole/total lock  
Code: 31 F XPU NI/...R



stem fitting  
Code: 31 Z XPU NI/...



stem fitting/total locking device  
Code: 31 FZ XPU NI/...

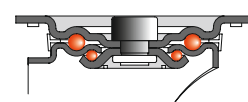

## Industrial swivel castor brackets with a load capacity of up to 225 kg

Housings made of stainless pressed steel. Swivel head with double ball bearings, dust and splash proof, with riveted kingpin. ALLSTOP total locking device on the trailing side of the housing, blocks rolling and swivel motion simultaneously.









PEVOLOP® - PEVOLOP®  
Solid rubber wheels and castors  
Electrically conductive wheels and castors  
VULVOLAN® - PEVOLOP® - Soft  
Stainless steel castors  
Institutional wheels and castors  
Conveyor/guiding rollers and ball units  
Profile rollers  
Pallet rollers  
Press-on tyres

# PE·VO·LON® electrically conductive stainless steel industrial castors









Series WBX NI

Series WLX NI

Article code	 mm	 mm	 mm	 mm	 mm	 mm	 mm	 kg
WLX NI/080/35/5R L	80	35	118	105 x 85	80 x 60	9	40	250
WLX NI/100/40/5R L	100	40	140	105 x 85	80 x 60	9	45	350
WLX NI/125/40/5R	125	40	178	135 x 110	105 x 80	11	50	600
WLX NI/150/50/5R	150	50	205	135 x 110	105 x 80	11	50	600
WLX NI/200/50/5R	200	50	250	135 x 110	105 x 80	11	55	750

## Heavy-duty stainless steel industrial swivel castors with electrically conductive PEVOLON® wheels

Wheels series AX with stainless ball bearings (/5R), see page 81.

Article code	 mm	 mm	 mm	 mm	 mm	 mm	 kg
WBX NI/080/35/5R L	80	35	118	105 x 85	80 x 60	9	250
WBX NI/100/40/5R L	100	40	140	105 x 85	80 x 60	9	350
WBX NI/125/40/5R	125	40	178	135 x 110	105 x 80	11	600
WBX NI/150/50/5R	150	50	205	135 x 110	105 x 80	11	600
WBX NI/200/50/5R	200	50	250	135 x 110	105 x 80	11	750

## Heavy-duty industrial fixed castors

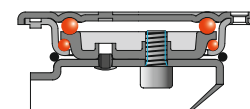

## Industrial swivel castor brackets with a load capacity of up to 750 kg

Housings made of strong stainless pressed steel. Swivel head with double ball bearings, dust and splash proof. Without kingpin. With grease nipple. ALLSTOP total locking device on the trailing side of the housing, blocks rolling and swivel motion simultaneously.

ALLSTOP total locking device  
Code: WLFX NI/...



PEVOLON® - PEVOPLASTIC®  
PEVOHA®

Solid rubber  
wheels and castors

Electrically conductive  
wheels and castors

VULVOLAN® - PEVOPLUR®  
PEVOVIM® - Soft

Stainless steel castors

Institutional  
wheels and castors

Conveyor/guiding  
rollers and ball units

Profile rollers

Puller rollers

Press-on tyres



# VULKOLLAN®/PE·VO·PUR®/PE·VO·DYN® PE·VO·DYN®-Soft wheels

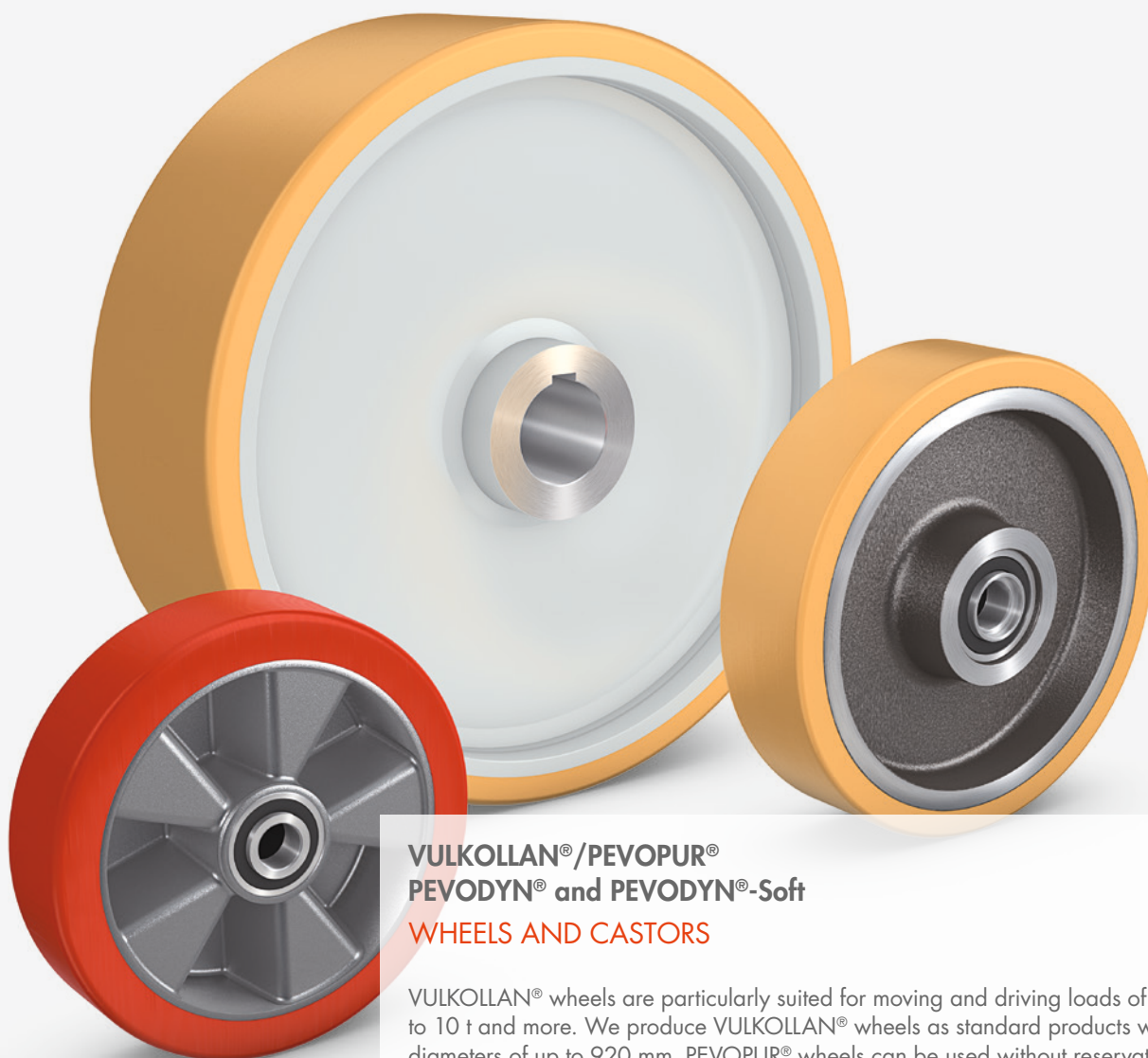

## VULKOLLAN®/PEVOPUR® PEVODYN® and PEVODYN®-Soft WHEELS AND CASTORS

VULKOLLAN® wheels are particularly suited for moving and driving loads of up to 10 t and more. We produce VULKOLLAN® wheels as standard products with diameters of up to 920 mm. PEVOPUR® wheels can be used without reservations for in-plant transportation with medium-sized loads. PEVODYN® wheels offer considerably reduced starting and rolling resistance as well as high dynamic loading capacity. PEVODYN® soft wheels also offer even greater driving comfort as well as better shock absorption and noise reduction. Depending on the model the swivel bracket is produced with different, high-quality bearings. Brake systems (e.g. ALLSTOP) can be provided as standard products for all swivel brackets.

PEVOLON® • PEVOLASTIC® PEVOTHA®
Solid rubber wheels and castors
Electrically conductive wheels and castors
VULKOLLAN® • PEVOPUR® PEVODYN® / -Soft
Stainless steel castors
Institutional wheels and castors
Conveyor/guiding rollers and ball units
Profile rollers
Pallet rollers
Press-on tyres

# VULKOLLAN®/PE·VO·PUR®/PE·VO·DYN®

## PE·VO·DYN®-Soft **product overview**

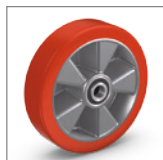

Series 183 ALU PD-S  
Series 181 PUR  
150 - 790 kg  
[Page 92](#)

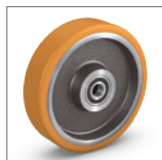

Series 178 PUR  
220 - 9.170 kg  
[Page 93](#)

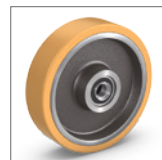

Series 178  
200 - 9.170 kg  
[Page 94](#)



Series 178 A  
450 - 2.500 kg  
[Page 95](#)



Series 173 GR  
Series 173 PD GR  
720 - 2.310 kg  
[Page 96](#)

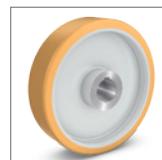

Series 171 A  
2.000 - 11.500 kg  
[Page 97](#)

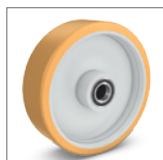

Series 171/5  
2.000 - 10.000 kg  
[Page 98](#)



Series 41 PUR  
Series 42 PUR  
200 - 400 kg  
[Page 100](#)



Series 41 PD-S  
Series 42 PD-S  
290 - 350 kg  
[Page 101](#)



Series 217 ALU PUR  
Series 218 ALU PUR  
280 - 700 kg  
[Page 102](#)



Series 217 PUR  
Series 218 PUR  
220 - 1.600 kg  
[Page 103](#)



Series 219 PUR  
Series 220 PUR  
250 - 725 kg  
[Page 104](#)



Series 223 PUR  
Series 224 PUR  
400 - 1.100 kg  
[Page 105](#)



Series 191  
Series 192  
550 - 2.000 kg  
[Page 106](#)



Series 191 PD-S  
Series 192 PD-S  
450 - 1.760 kg  
[Page 107](#)



Series 191 GU  
Series 192 GU  
650 - 1.500 kg  
[Page 108](#)



Series 191 D  
Series 192 D  
1.100 - 4.300 kg  
[Page 109](#)



Series 191 D PD-S  
Series 192 D PD-S  
900 - 3.520 kg  
[Page 110](#)



Series 195  
Series 196  
800 - 4.000 kg  
[Page 111](#)



Series 195 D  
Series 196 D  
900 - 5.000 kg  
[Page 112](#)



Series 37 TRI PUR  
250 - 3.000 kg  
[Page 113](#)

PEVOLON® - PEVOPLASTIC®  
PEVOTHAN®

Solid rubber  
wheels and castors

Electrically conductive  
wheels and castors

VULKOLLAN® - PEVOPLUR®  
PEVODYN® - Soft

Stainless steel castors

Institutional  
wheels and castors

Conveyor/guiding  
rollers and ball units

Profile rollers

Pallet rollers





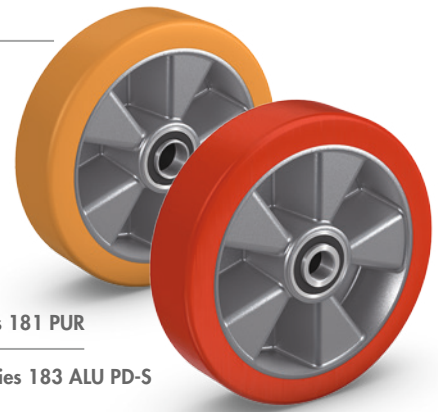

Press-on tyres

# PE·VO·DYN®-Soft / PE·VO·PUR® wheels









Series 181 PUR

Series 183 ALU PD-S

 Article code	 mm	 mm	 mm	 mm	 mm	 kg
183 ALU PD-S/100/040/5/15	100	40	45	45	15	290
183 ALU PD-S/125/050/5/20	125	50	54	60	20	450
183 ALU PD-S/150/050/5/20	150	50	54	59	20	550
183 ALU PD-S/160/050/5/20	160	50	54	59	20	580
183 ALU PD-S/180/050/5/20	180	50	54	59	20	660
183 ALU PD-S/200/050/5/20	200	50	54	60	20	660
183 ALU PD-S/200/050/5/25	200	50	54	60	25	660
183 ALU PD-S/250/060/5/20	250	60	60	60	20	790
183 ALU PD-S/250/060/5/25	250	60	60	60	25	760

## PEVODYN®-SOFT wheels with aluminium rim

Aluminium wheel centre with ball bearings (/5). Direct bonded PEVODYN®-SOFT tread (78° Shore A).

 Article code	 mm	 mm	 mm	 mm	 mm	 kg
181 PUR/080/025/5/15	80	25	30	28	15	150
181 PUR/100/040/5/15 B*	100	40	45	45	15	300
181 PUR/100/040/5/15	100	40	45	45	15	350
181 PUR/125/040/5/15	125	40	40	46	15	380
181 PUR/125/050/5/20	125	50	54	60	20	400
181 PUR/150/050/5/20	150	50	54	60	20	450
181 PUR/160/050/5/20	160	50	54	59	20	500
181 PUR/180/050/5/20 B*	180	50	54	59	20	550
181 PUR/200/050/5/20	200	50	54	60	20	700
181 PUR/200/050/5/25	200	50	54	60	25	700
181 PUR/250/050/5/20	250	50	60	60	20	790
181 PUR/250/060/5/25	250	60	60	60	25	790

\* with crowned tread

## PEVOPUR® wheels with aluminium rim

Aluminium wheel centre with ball bearings (/5). Direct bonded PEVOPUR® tread (93° Shore A).

PEVOPUR® - PEVODYN®  
PEVOTHA®

Solid rubber  
wheels and castors

Electrically conductive  
wheels and castors

VULKOLLAN® - PEVOPUR®  
PEVODYN® - Soft

Stainless steel castors

Institutional  
wheels and castors

Conveyor/guiding  
rollers and ball units

Profile rollers

Pallet rollers

Press-on tyres

# PE·VO·PUR®







## heavy-duty wheels



Series 178 PUR

### PEVOPUR® heavy-duty wheels with cast rim

Grey cast iron wheel centre with ball bearings (/5). Direct bonded PEVOPUR® tread (93° Shore A).

Article code	 mm	 mm	 mm	 mm	 mm	 mm	 kg
178 PUR/080/030/5/12	80	30	40	40	45	12	220
178 PUR/100/025/5/15	100	25	25	26	43	15	220
178 PUR/100/035/5/12	100	35	40	40	42	12	300
178 PUR/100/035/5/15	100	35	40	38	42	15	300
178 PUR/100/040/5/15	100	40	45	42	45	15	350
178 PUR/100/040/5/20	100	40	45	45	45	20	360
178 PUR/100/050/5/25	100	50	50	48	—	25	450
178 PUR/125/040/5/15	125	40	45	45	42	15	450
178 PUR/150/050/5/20	150	50	50	54	61	20	660
178 PUR/150/060/5/20	150	60	60	60	77	20	800
178 PUR/160/040/5/20	160	40	45	49	61	20	550
178 PUR/160/050/5/20	160	50	60	60	65	20	660
178 PUR/200/050/5/20	200	50	56	56	65	20	1.000
178 PUR/200/075/5/25	200	75	80	80	70	25	1.350
178 PUR/200/080/5/25	200	80	80	84	72	25	1.400
178 PUR/250/050/5/25	250	50	60	64	67	25	1.100
178 PUR/250/060/5/25	250	60	60	60	77	25	1.350
178 PUR/250/075/5/30	250	75	75	75	77	30	1.700
178 PUR/250/080/5/30	250	80	80	80	75	30	1.700
178 PUR/300/060/5/30	300	60	65	65	82	30	1.600
178 PUR/300/075/5/40	300	75	75	75	105	40	2.000
178 PUR/300/080/5/40	300	80	85	85	105	40	2.100
178 PUR/300/100/5/40	300	100	110	110	105	40	1.930
178 PUR/360/060/5/30	360	60	60	60	111	30	1.140
178 PUR/400/075/5/45	400	75	85	85	131	45	1.480
178 PUR/400/100/5/50	400	100	100	100	130	50	3.660
178 PUR/500/200/5/90	500	200	200	200	230	90	9.170

PEVOPUR® • PEVOPLASTIC®  
PEVOTHAN®

Solid rubber  
wheels and castors

Electrically conductive  
wheels and castors

VULKOLLAN® • PEVOPUR®  
PEVODIN® / -Soft

Stainless steel castors

Institutional  
wheels and castors

Conveyor/guiding  
rollers and ball units

Profile rollers

Pallet rollers

Press-on tyres

# VULKOLLAN® load wheels



Series 178

## VULKOLLAN® load wheels

Grey cast iron wheel centre with ball bearings (/5). Direct bonded VULKOLLAN® tread (93° Shore A).

Article code	mm	mm	mm	mm	mm	mm	kg
178/100/025/5/15	100	25	25	26	43	15	200
178/100/035/5/12	100	35	40	40	42	12	300
178/100/040/5/15 B*	100	40	45	42	45	15	350
178/100/040/5/15	100	40	45	42	45	15	350
178/100/040/5/25	100	40	45	45	54	25	350
178/100/050/5/20 B*	100	50	50	54	-	20	450
178/100/050/5/25-1	100	50	50	54	-	25	450
178/100/050/5/25-2	100	50	50	48	-	25	450
178/125/040/5/15	125	40	45	45	42	15	450
178/125/040/5/20	125	40	45	43	60	20	450
178/125/050/5/20	125	50	50	54	59	20	560
178/125/050/5/25-1	125	50	50	54	59	25	560
178/125/050/5/25-2	125	50	50	48	59	25	560
178/125/070/5/25	125	70	70	74	65	25	660
178/150/035/5/25	150	35	35	39	62	25	450
178/150/050/5/20	150	50	50	54	61	20	660
178/150/050/5/25-1	150	50	50	54	61	25	660
178/150/050/5/25-2	150	50	50	48	61	25	660
178/150/080/5/25	150	80	72	78	65	25	900
178/160/040/5/20	160	40	45	49	61	20	550
178/160/050/5/20	160	50	60	60	65	20	700
178/160/050/5/25	160	50	50	48	70	25	600
178/180/050/5/25	180	50	50	48	66	25	800
178/200/050/5/20	200	50	60	64	65	20	1.000
178/200/050/5/25	200	50	60	64	65	25	1.000
178/200/050/5/30	200	50	50	48	86	30	840
178/200/060/5/25	200	60	60	60	65	25	760
178/200/080/5/25-1	200	80	80	84	70	25	1.400
178/200/080/5/25-2	200	80	78	78	95	25	1.400
178/200/080/5/30	200	80	78	78	85	30	1.400
178/200/080/5/35	200	80	80	78	82	35	1.460
178/250/050/5/25	250	50	60	64	67	25	1.100
178/250/050/5/30	250	50	50	48	83	30	1.100
178/250/060/5/25	250	60	60	60	77	25	1.350
178/250/080/5/30-1	250	80	80	80	75	30	1.700
178/250/080/5/30-2	250	80	78	78	91	30	1.800
178/250/080/5/40	250	80	80	78	101	40	1.800
178/300/060/5/30	300	60	65	65	82	30	1.600
178/300/080/5/40	300	80	85	85	106	40	2.100
178/300/100/5/50	300	100	100	100	105	50	2.750
178/300/135/5/50	300	135	135	135	140	50	3.400
178/400/075/5/45	400	75	80	80	131	45	2.200
178/400/100/5/50	400	100	100	100	130	50	3.660
178/500/085/5/50	500	85	100	100	140	50	2.360
178/500/200/5/90	500	200	200	200	230	90	9.170

\* with crowned tread

PEVOLON® - PEVOPLASTIC®  
PEVOTHA®

Solid rubber  
wheels and castors

Electrically conductive  
wheels and castors

VULKOLLAN® - PEVOPLUR®  
PEVODIN® / -Soft

Stainless steel castors

Institutional  
wheels and castors

Conveyor/guiding  
rollers and ball units

Profile rollers







Pallet rollers

Press-on tyres

# VULKOLLAN® drive wheels



Series 178 A

Article code	 mm	 mm	 mm	 mm	 mm	 mm	 kg
178 A/100/050/2/25 H7	100	50	50	–	25	450	
178 A/125/040/2/20 H7	125	40	36	46	20	450	
178 A/125/040/2/25 H7	125	40	45	60	25	450	
178 A/125/050/2/25 H7	125	50	50	60	25	560	
178 A/125/050/2/30 H7	125	50	50	60	30	560	
178 A/125/050/2/35 H7	125	50	50	60	35	560	
178 A/150/050/2/30 H7	150	50	50	61	30	650	
178 A/150/050/2/35 H7	150	50	50	61	35	650	
178 A/150/050/2/40 H7	150	50	50	61	40	660	
178 A/160/050/2/25 H7	160	50	50	61	25	700	
178 A/160/050/2/35 H7	160	50	50	61	35	700	
178 A/180/055/2/35 H7	180	55	60	63	35	850	
178 A/200/050/2/30 H7	200	50	60	65	30	1.000	
178 A/200/050/2/35 H7	200	50	60	85	35	1.000	
178 A/200/050/2/40 H7	200	50	60	85	40	1.000	
178 A/200/080/2/50 H7	200	80	80	95	50	1.400	
178 A/250/050/2/40 H7	250	50	50	90	40	1.100	
178 A/250/050/2/50 H7	250	50	60	90	50	1.100	
178 A/250/080/2/30 H7	250	80	80	100	30	1.800	
178 A/250/080/2/40 H7	250	80	80	100	40	1.800	
178 A/250/080/2/50 H7	250	80	80	100	50	1.800	
178 A/300/060/2/40 H7	300	60	65	82	40	1.600	
178 A/300/060/2/50 H7	300	60	65	80	50	1.600	
178 A/300/080/2/50 H7	300	80	80	107	50	2.100	
178 A/300/100/2/40 H7	300	100	100	106	40	2.500	
178 A/300/100/2/60 H7	300	100	110	105	60	2.500	

## VULKOLLAN® drive wheels

Grey cast iron wheel centre with bore and keyway according to DIN 6885. Direct bonded VULKOLLAN® tread (93° Shore A).

PEVOLON® • PEVOPLASTIC®  
PEVOTHA®

Solid rubber  
wheels and castors

Electrically conductive  
wheels and castors

VULKOLLAN® • PEVOPLUR®  
PEVODYN® / -Soft

Stainless steel castors

Institutional  
wheels and castors

Conveyor/guiding  
rollers and ball units

Profile rollers

Pallet rollers

Press-on tyres

# VULKOLLAN®/PE·VO·DYN®

## basic wheels



Series 173 PD GR

Series 173 GR

Article code	mm	mm	mm	mm	mm	kg
173 GR/125/060/2/15 H7	125	60	67	60	15	720
173 GR/150/060/2/15 H7	150	60	67	60	15	860
173 GR/160/050/2/20 H7	160	50	57	80	20	770
173 GR/160/060/2/20 H7	160	60	67	80	20	920
173 GR/200/050/2/20 H7	200	50	50	90	20	960
173 GR/200/060/2/20 H7	200	60	67	80	20	1.150
173 GR/200/080/2/20 H7	200	80	80	90	20	1.540
173 GR/250/050/2/25 H7	250	50	50	130	25	1.200
173 GR/250/080/2/25 H7	250	80	80	130	25	1.920
173 GR/250/090/2/25 H7	250	90	90	130	25	2.160
173 GR/300/080/2/30 H7	300	80	80	180	30	2.310

### VULKOLLAN® basic wheels

Steel wheel centre C45 with pre-drilled bore for individual machining of the core bore. All wheels are equipped with clamping trough. Direkt bondet VULKOLLAN® tread (93° Shore A).

Article code	mm	mm	mm	mm	mm	kg
173 PD GR/125/060/2/15 H7	125	60	67	60	15	680
173 PD GR/150/060/2/15 H7	150	60	67	60	15	820
173 PD GR/160/050/2/20 H7	160	50	57	80	20	730
173 PD GR/160/060/2/20 H7	160	60	67	80	20	880
173 PD GR/200/050/2/20 H7	200	50	50	90	20	910
173 PD GR/200/060/2/20 H7	200	60	67	80	20	1.100
173 PD GR/200/080/2/20 H7	200	80	80	90	20	1.460
173 PD GR/250/050/2/25 H7	250	50	50	130	25	1.140
173 PD GR/250/080/2/25 H7	250	80	80	130	25	1.830
173 PD GR/300/080/2/30 H7	300	80	80	180	30	2.200

### PEVODYN® basic wheels

Steel wheel centre C45 with pre-drilled bore for individual machining of the core bore. All wheels are equipped with clamping trough. Direkt bondet PEVODYN® tread (93° Shore A).

PEVODYN® is particularly suitable for use in intralogistic applications and offers an alternative to conventional polyurethan-materials and has been developed in order to guarantee highest load capacity at maximum speed. PEVODYN® wheels are characterized by a low starting and rolling resistance. Due to its hydrolysis-stability this material is perfectly suited for use in areas with tropical climate.

PEVOLLAN® - PEVOLLASTIC®  
PEVOTHAN®

Solid rubber  
wheels and castors

Electrically conductive  
wheels and castors

VULKOLLAN® - PEVOPUR®  
PEVODYN® - Soft

Stainless steel castors

Institutional  
wheels and castors

Conveyor/guiding  
rollers and ball units

Profile rollers

Pallet rollers

Press-on tyres

# VULKOLLAN®



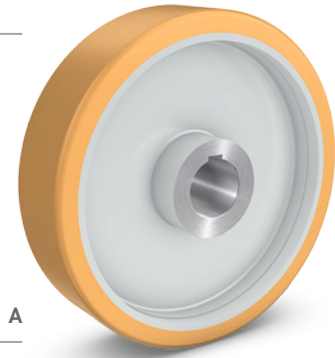



## heavy-duty drive wheels



Series 171 A

### VULKOLLAN® heavy-duty drive wheels

Stable welded wheel centre with bore and keyway according to DIN 6885. Direct bonded VULKOLLAN® tread (93° Shore A).

Article code	 mm	 mm	 mm	 mm	 mm	 kg
171 A/300/075/260/2/50 H7	300	75	85	96	50	2.000
171 A/300/100/260/2/60 H7	300	100	110	116	60	2.500
171 A/360/075/310/2/70 H7	360	75	85	116	70	2.500
171 A/360/100/310/2/60 H7	360	100	110	116	60	3.000
171 A/400/100/350/2/70 H7	400	100	110	121	70	3.500
171 A/400/120/350/2/60 H7	400	120	130	116	60	4.000
171 A/400/120/350/2/70 H7	400	120	130	116	70	4.000
171 A/400/150/350/2/60 H7	400	150	160	117	60	5.500
171 A/500/100/450/2/60 H7	500	100	110	116	60	4.500
171 A/500/150/450/2/80 H7	500	150	160	136	80	5.700
171 A/500/200/450/2/80 H7	500	200	210	135	80	8.000
171 A/600/150/550/2/80 H7	600	150	160	116	80	8.250
171 A/600/200/550/2/80 H7	600	200	210	135	80	10.000
171 A/700/200/640/2/80 H7	700	200	210	136	80	11.500

VULKOLLAN® heavy-duty drive wheels with connecting bore hole or for the reception of clamping sets available on request.

PEVOPUR® - PEVOPLASTIC®  
PEVOTHAN®

Solid rubber  
wheels and castors

Electrically conductive  
wheels and castors

VULKOLLAN® - PEVOPUR®  
PEVODIN® - Soft

Stainless steel castors

Institutional  
wheels and castors

Conveyor/guiding  
rollers and ball units

Profile rollers

Pallet rollers

Press-on tyres







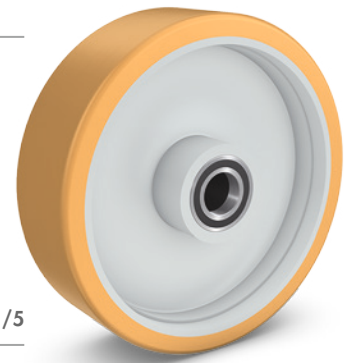

# VULKOLLAN®

## heavy-duty wheels



Series 171/5

Article code	 mm	 mm	 mm	 mm	 mm	 mm	 kg
171/300/075/260/5/35	300	75	80	80	96	35	2.000
171/300/100/260/5/35	300	100	110	110	116	35	2.500
171/360/075/310/5/40	360	75	80	80	116	40	2.500
171/360/100/310/5/40	360	100	110	110	116	40	3.000
171/400/100/350/5/40	400	100	110	110	116	40	3.500
171/400/120/350/5/50	400	120	130	130	116	50	4.000
171/400/150/350/5/50	400	150	160	160	117	50	4.300
171/500/100/450/5/50	500	100	110	110	136	50	4.500
171/500/120/450/5/50	500	120	130	130	136	50	5.000
171/500/150/450/5/50	500	150	160	160	136	50	5.700
171/500/200/450/5/80	500	200	210	210	197	80	8.000
171/600/150/550/5/80	600	150	160	160	203	80	8.000
171/600/200/550/5/80	600	200	210	210	199	80	10.000

### VULKOLLAN® heavy-duty wheels

Stable welded wheel centre with ball bearings (/5). Direct bonded VULKOLLAN® tread (93° Shore A).

PEVOLON® • PEVOPLASTIC®  
PEVOTHA®

Solid rubber  
wheels and castors

Electrically conductive  
wheels and castors

VULKOLLAN® • PEVOPUR®  
PEVODYN® - Soft

Stainless steel castors

Institutional  
wheels and castors

Conveyor/guiding  
rollers and ball units

Profile rollers

Pallet rollers

Press-on tyres

# VULKOLLAN®/PE·VO·PUR® PE·VO·DYN®-Soft **castors**



PEVOLON® - PEVOPLASTIC®  
PEVOTHAN®

Solid rubber  
wheels and castors

Electrically conductive  
wheels and castors

VULKOLLAN® - PEVOPUR®  
PEVOVYN® - Soft

Stainless steel castors

Institutional  
wheels and castors

Conveyor/guiding  
rollers and ball units

Profile rollers

Roller rollers

Press-on tyres

# PE·VO·PUR® industrial castors



Series 42 PUR

Series 41 PUR

## Industrial swivel castors with PEVOPUR® wheels

Reinforced pressed steel bracket. With wheels series 181 PUR with ball bearings (/5), see page 92.

Article code	mm	mm	mm	mm	mm	mm	mm	kg
41 PUR/080/32/5 B*	80	32	100	105 x 80	80 x 60	9	36	200
41 PUR/100/40/5	100	40	125	135 x 110	105 x 80	11	45	350
41 PUR/100/40/5 B*	100	40	125	135 x 110	105 x 80	11	45	350
41 PUR/125/50/5	125	50	164	135 x 110	105 x 80	11	55	350
41 PUR/150/50/5	150	50	194	135 x 110	105 x 80	11	55	350
41 PUR/200/50/5	200	50	239	135 x 110	105 x 80	11	55	400

## Industrial fixed castors

Article code	mm	mm	mm	mm	mm	mm	kg
42 PUR/080/32/5 B*	80	32	100	105 x 80	80 x 60	9	200
42 PUR/100/40/5	100	40	126	135 x 110	105 x 80	11	350
42 PUR/100/40/5 B*	100	40	125	135 x 112	105 x 80	11	350
42 PUR/125/50/5	125	50	164	135 x 110	105 x 80	11	350
42 PUR/150/50/5	150	50	194	135 x 110	105 x 80	11	350
42 PUR/200/50/5	200	50	239	135 x 110	105 x 80	11	400

\* with crowned tread

1-way directional lock not available for plate 105 x 80 mm.

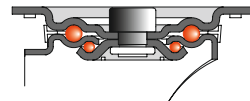

## Industrial swivel castor brackets with a load capacity of up to 400 kg

Housings made of pressed steel, zinc and chromated. Swivel head with double ball bearings, dust and splash proof, with riveted kingpin. ALLSTOP total locking device on the trailing side of the housing, blocks rolling and swivel motion simultaneously.

ALLSTOP total locking device  
Code: 41 F PUR/...



directional lock  
Code: 41 PUR/...1RIF



4-way directional lock  
Code: 41 PUR/...4RIF



# PE·VO·DYN®-Soft industrial castors



Series 42 PD-S

Series 41 PD-S



Article code



kg

Article code	mm	mm	mm	mm	mm	mm	mm	kg
41 PD-S/100/40/5	100	40	125	135 x 110	105 x 80	11	45	290
41 PD-S/125/50/5	125	50	164	135 x 110	105 x 80	11	55	300
41 PD-S/160/50/5	160	50	199	135 x 110	105 x 80	11	55	300
41 PD-S/200/50/5	200	50	239	135 x 110	105 x 80	11	55	350
41 PD-S/250/60/5	250	60	290	135 x 110	105 x 80	11	55	350

## Industrial swivel castors with PEVODYN®-Soft wheels

Wheels series 183 ALU PD-S with ball bearings (/5), see page 92.



Article code



kg

Article code	mm	mm	mm	mm	mm	mm	kg
42 PD-S/100/40/5	100	40	125	135 x 112	105 x 80	11	290
42 PD-S/125/50/5	125	50	164	135 x 110	105 x 80	11	300
42 PD-S/160/50/5	160	50	199	135 x 110	105 x 80	11	300
42 PD-S/200/50/5	200	50	239	135 x 110	105 x 80	11	350
42 PD-S/250/60/5	250	60	290	135 x 110	105 x 80	11	350

## Industrial fixed castors

## Industrial swivel castor brackets with a load capacity of up to 350 kg

Housings made of pressed steel, zinc and chromated. Swivel head with double ball bearings, dust and splash proof, with riveted kingpin. ALLSTOP total locking device on the trailing side of the housing, blocks rolling and swivel motion simultaneously.

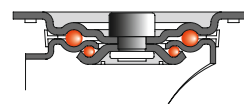

ALLSTOP total locking device  
Code: 41 F PD-S/...



directional lock  
Code: 41 PD-S/...1RIF



4-way directional lock  
Code: 41 PD-S/...4RIF



PEVODYN® - PEVOPLASTIC®  
PEVOTHA®

Solid rubber  
wheels and castors

Electrically conductive  
wheels and castors

VULKOLLAN® - PEVOPLUR®  
PEVODYN® / -Soft

Stainless steel castors

Institutional  
wheels and castors

Conveyor/guiding  
rollers and ball units

Profile rollers

Pallet rollers

Press-on tyres

# PE·VO·PUR® industrial castors



Series 218 ALU PUR

Series 217 ALU PUR

Article code	mm	mm	mm	mm	mm	mm	mm	kg
217 ALU PUR/100/40/5 L	100	40	140	105 x 85	80 x 60	9	45	280
217 ALU PUR/100/40/5	100	40	148	135 x 110	105 x 80	11	50	280
217 ALU PUR/125/40/5 L	125	40	165	105 x 85	80 x 60	9	45	350
217 ALU PUR/125/50/5	125	50	178	135 x 110	105 x 80	11	50	400
217 ALU PUR/160/50/5	160	50	210	135 x 110	105 x 80	11	50	500
217 ALU PUR/200/50/5	200	50	250	135 x 110	105 x 80	11	55	700

## Heavy-duty industrial swivel castors with PEVOPUR® wheels

Wheels series 181 PUR with ball bearings (1/5), see page 92.

Article code	mm	mm	mm	mm	mm	mm	kg
218 ALU PUR/100/40/5 L	100	40	140	105 x 85	80 x 60	9	280
218 ALU PUR/100/40/5	100	40	148	135 x 110	105 x 80	11	280
218 ALU PUR/125/40/5 L	125	40	165	105 x 85	80 x 60	9	350
218 ALU PUR/125/50/5	125	50	178	135 x 110	105 x 80	11	400
218 ALU PUR/160/50/5	160	50	210	135 x 110	105 x 80	11	500
218 ALU PUR/200/50/5	200	50	250	135 x 110	105 x 80	11	700

## Heavy-duty industrial fixed castors

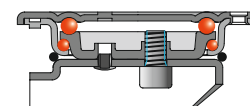

## Industrial swivel castor brackets with a load capacity of up to 700 kg

Housings made of strong pressed steel, zinc and chromated. Swivel head with double ball bearings, dust and splash proof. Without kingpin. With grease nipple. ALLSTOP total locking device on the trailing side of the housing, blocks rolling and swivel motion simultaneously.

ALLSTOP total locking device  
Code: 217 F ALU PUR/...



4-way directional lock  
Code: 217 ALU PUR/...4RIF



wheel and directional lock  
Code: 217 F ALU PUR/...4RIF



foot protection  
Code: ...PRO



PEVOPUR® - PEVOPLASTIC®  
PEVOHAN®

Solid rubber  
wheels and castors

Electrically conductive  
wheels and castors

VULKOLLAN® - PEVOPUR®  
PEVOVIM® - Soft

Stainless steel castors

Institutional  
wheels and castors

Conveyor/guiding  
rollers and ball units

Profile rollers

Pallet rollers

Press-on tyres

# PE·VO·PUR® industrial castors



Series 218 PUR

Series 217 PUR

Article code	mm	mm	mm	mm	mm	mm	mm	kg
217 PUR/080/30/5 L	80	30	118	105 x 85	80 x 60	9	40	220
217 PUR/100/35/5 L	100	35	140	105 x 85	80 x 60	9	45	300
217 PUR/100/35/5	100	35	148	135 x 110	105 x 80	11	50	300
217 PUR/125/40/5 L	125	40	165	105 x 85	80 x 60	9	45	350
217 PUR/125/40/5	125	40	178	135 x 110	105 x 80	11	50	400
217 PUR/160/40/5	160	40	210	135 x 110	105 x 80	11	50	550
217 PUR/200/50/5	200	50	250	135 x 110	105 x 80	11	55	750
217 PUR/250/50/5	250	50	307	200 x 160	160 x 120	15	63	1.150
217 PUR/300/60/5	300	60	347	200 x 160	160 x 120	15	73	1.600

## Heavy-duty industrial swivel castors with PEVOPUR® wheels

Wheels series 178 PUR with ball bearings (1/5), see page 93.

Article code	mm	mm	mm	mm	mm	mm	kg
218 PUR/080/30/5 L	80	30	118	105 x 85	80 x 60	9	220
218 PUR/100/35/5 L	100	35	140	105 x 85	80 x 60	9	300
218 PUR/100/35/5	100	35	148	135 x 110	105 x 80	11	300
218 PUR/125/40/5 L	125	40	165	105 x 85	80 x 60	9	350
218 PUR/125/40/5	125	40	178	135 x 110	105 x 80	11	400
218 PUR/160/40/5	160	40	210	135 x 110	105 x 80	11	550
218 PUR/200/50/5	200	50	250	135 x 110	105 x 80	11	750
218 PUR/250/50/5	250	50	307	200 x 160	160 x 120	15	1.150
218 PUR/300/60/5	300	60	347	200 x 160	160 x 120	15	1.600

## Heavy-duty industrial fixed castors

4-way directional lock not available for plate 200 x 160 mm.

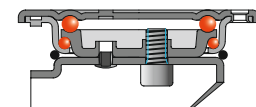

## Industrial swivel castor brackets with a load capacity of up to 1,600 kg

Housings made of strong pressed steel, zinc and chromated, or stainless steel. Swivel head with double ball bearings, dust and splash proof. Without kingpin. With grease nipple. ALLSTOP total locking device on the trailing side of the housing, blocks rolling and swivel motion simultaneously.

ALLSTOP total locking device  
Code: 217 F PUR/...\*



4-way directional lock  
Code: 217 PUR/...4RIF



wheel and directional lock  
Code: 217 F PUR/...4RIF



foot protection  
Code: ...PRO



\* Plate 200 x 160 mm with ALLSTOP total locking device on the non-trailing side of the housing.

PEVOPUR® - PEVOELASTIC®  
PEVOTHA®

Solid rubber wheels and castors

Electrically conductive wheels and castors

VULKOLLAN® - PEVOPUR®  
PEVODVM® - Soft

Stainless steel castors

Industrial wheels and castors

Conveyor/guiding rollers and ball units

Profile rollers

Pallet rollers





Press-on tyres

# PE·VO·PUR® industrial castors











Series 220 PUR

Series 219 PUR

								
Article code	mm	mm	mm	mm	mm	mm	mm	kg
219 PUR/100/35/5 L	100	35	129	100 x 85	80 x 60	9	47	250
219 PUR/125/40/5 L	125	40	161	100 x 85	80 x 60	9	51	275
219 PUR/125/50/5	125	50	164	135 x 110	105 x 80	12	62	500
219 PUR/150/50/5	150	50	195	135 x 110	105 x 80	12	60	625
219 PUR/200/50/5	200	50	242	135 x 110	105 x 80	12	59	725

## Heavy-duty industrial swivel castors with PEVOPUR® wheels

Wheels series 178 PUR with ball bearings (/5), see page 93.

							
Article code	mm	mm	mm	mm	mm	mm	kg
220 PUR/100/35/5 L	100	35	129	100 x 90	80 x 60	9	250
220 PUR/125/40/5 L	125	40	161	100 x 90	80 x 60	9	275
220 PUR/125/50/5	125	50	164	135 x 115	105 x 80	12	500
220 PUR/150/50/5	150	50	195	135 x 115	105 x 80	12	625
220 PUR/200/50/5	200	50	242	135 x 115	105 x 80	12	725

## Heavy-duty industrial fixed castors

## Industrial swivel castor brackets with a load capacity of up to 725 kg

Housings made of strong pressed steel, zinc and chromated. Swivel head with double needle roller thrust bearings and a ball bearing race guiding the kingpin. Upper needle roller bearing in hardened steel bearing shells. Kingpin bolted and secured. ALLSTOP total locking device on the non-trailing side of the housing, blocks rolling and swivel motion simultaneously.

ALLSTOP total locking device  
Code: 219 F PUR/...



foot protection  
Code: ...PRO

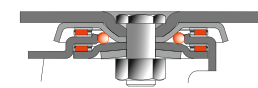



PEVOLAN® • PEVOELASTIC®  
PEVOTAN®  
Solid rubber wheels and castors  
Electrically conductive wheels and castors  
VULKOLLAN® • PEVOPUR® PEVODYN® - Soft  
Stainless steel castors  
Institutional wheels and castors  
Conveyor/guiding rollers and ball units  
Profile rollers  
Pallet rollers  
Press-on tyres

# PE·VO·PUR® industrial castors





Series 224 PUR

Series 223 PUR

								
Article code	mm	mm	mm	mm	mm	mm	mm	kg
223 PUR/080/57/5	80	57	138	135 x 110	105 x 80	11	55	400
223 PUR/100/50/5	100	50	148	135 x 110	105 x 80	11	55	450
223 PUR/125/50/5	125	50	175	135 x 110	105 x 80	11	55	550
223 PUR/150/50/5	150	50	202	135 x 110	105 x 80	11	55	700
223 PUR/200/50/5	200	50	252	135 x 110	105 x 80	11	60	1.000
223 PUR/250/60/5	250	60	300	135 x 110	105 x 80	11	65	1.100

## Heavy-duty industrial swivel castors with PEVOPUR® wheels

Wheels series 178 PUR with ball bearings (/5), see page 93.

							
Article code	mm	mm	mm	mm	mm	mm	kg
224 PUR/080/57/5	80	57	138	135 x 110	105 x 80	11	400
224 PUR/100/50/5	100	50	148	135 x 110	105 x 80	11	450
224 PUR/125/50/5	125	50	175	135 x 110	105 x 80	11	550
224 PUR/150/50/5	150	50	202	135 x 110	105 x 80	11	700
224 PUR/200/50/5	200	50	252	135 x 110	105 x 80	11	1.000
224 PUR/250/60/5	250	60	300	135 x 110	105 x 80	11	1.100

## Heavy-duty industrial fixed castors

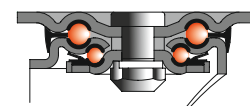

## Industrial swivel castor brackets with a load capacity of up to 1,100 kg

Housings made of extra strong pressed steel, zinc and chromated. Swivel head with double ball bearing. Bearing shells made of hardened steel. Kingpin bolted and secured. ALLSTOP total locking device on the trailing side of the housing, blocks rolling and swivel motion simultaneously.

**ALLSTOP total locking device**  
Code: 223 F PUR/...



**directional lock**  
Code: 223 PUR/...1RIF



**foot protection**  
Code: ...PRO



PEVOLAN® - PEVOELASTIC®  
PEVOTHA®

Solid rubber  
wheels and castors

Electrically conductive  
wheels and castors

VULKOLLAN® - PEVOPUR®  
PEVODYN® / -Soft

Stainless steel castors

Institutional  
wheels and castors

Conveyor/guiding  
rollers and ball units

Profile rollers

Pallet rollers

Press-on tyres



# PE·VO·PUR® heavy-duty castors



Series 192

Series 191

Article code	mm	mm	mm	mm	mm	mm	mm	kg
191/125/50/5	125	50	170	140 x 110	105 x 80	13	47	550
191/150/50/5	150	50	200	140 x 110	105 x 80	13	55	700
191/200/50/5	200	50	245	140 x 110	105 x 80	13	60	1.000
191/200/80/5	200	80	255	175 x 140	140 x 105	15	65	1.400
191/250/60/5	250	60	305	175 x 140	140 x 105	15	75	1.350
191/250/80/5	250	80	305	175 x 140	140 x 105	15	75	1.500
191/300/80/5	300	80	355	175 x 140	140 x 105	15	85	2.000

## Heavy-duty swivel castors with PEVOPUR® wheels

Wheels series 178 PUR with ball bearings (/5), see page 93.

Article code	mm	mm	mm	mm	mm	mm	kg
192/125/50/5	125	50	170	140 x 110	105 x 80	13	550
192/150/50/5	150	50	200	140 x 110	105 x 80	13	700
192/200/50/5	200	50	245	140 x 110	105 x 80	13	1.000
192/200/80/5	200	80	255	175 x 140	140 x 105	15	1.400
192/250/60/5	250	60	305	175 x 140	140 x 105	15	1.350
192/250/80/5	250	80	305	175 x 140	140 x 105	15	1.500
192/300/80/5	300	80	355	175 x 140	140 x 105	15	2.000

## Heavy-duty fixed castors

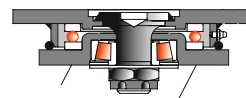

## Precision heavy-duty swivel castor brackets with a load capacity of up to 2,000 kg

Housings in precise highly stable welded steel construction. Swivel head with a high quality thrust ball bearing and a tapered roller bearing for the guidance of the kingpin. All bearing parts dust and splash proof. ALLSTOP total locking device on the non-trailing side of the housing, blocks rolling and swivel motion simultaneously.

ALLSTOP total locking device  
Code: 191 F/...



4-way directional lock  
Code: 191/...4RIF



wheel and directional lock  
Code: 191 F/...4RIF



foot protection  
Code: ...PRO



PEVOPUR® - PEVOPLASTIC®  
PEVOHAN®

Solid rubber  
wheels and castors

Electrically conductive  
wheels and castors

VULKOLLAN® - PEVOPUR®  
PEVOHAN® - Soft

Stainless steel castors

Institutional  
wheels and castors

Conveyor/guiding  
rollers and ball units

Profile rollers

Pallet rollers

Press-on tyres

# PE·VO·DYN®-Soft heavy-duty castors



Series 192 PD-S

Series 191 PD-S

## Heavy-duty swivel castors with PEVODYN®-Soft wheels

Wheels series 183 ALU PD-S/  
178 PD-S with ball bearings (/5),  
see page 92.

Article code	mm	mm	mm	mm	mm	mm	mm	kg
191 PD-S/125/50/5	125	50	170	140 x 110	105 x 80	13	47	450
191 PD-S/150/50/5	150	50	200	140 x 110	105 x 80	13	55	550
191 PD-S/200/50/5	200	50	245	140 x 110	105 x 80	13	60	660
191 PD-S/200/80/5*	200	80	255	175 x 140	140 x 105	15	65	760
191 PD-S/250/60/5	250	60	305	175 x 140	140 x 105	15	75	790
191 PD-S/250/80/5*	250	80	305	175 x 140	140 x 105	15	75	1.460
191 PD-S/300/80/5*	300	80	355	175 x 140	140 x 105	15	85	1.760

## Heavy-duty fixed castors

Article code	mm	mm	mm	mm	mm	mm	kg
192 PD-S/125/50/5	125	50	170	140 x 110	105 x 80	13	450
192 PD-S/150/50/5	150	50	200	140 x 110	105 x 80	13	550
192 PD-S/200/50/5	200	50	245	140 x 110	105 x 80	13	660
192 PD-S/200/80/5*	200	80	255	175 x 140	140 x 105	15	760
192 PD-S/250/60/5	250	60	305	175 x 140	140 x 105	15	790
192 PD-S/250/80/5*	250	80	305	175 x 140	140 x 105	15	1.460
192 PD-S/300/80/5*	300	80	355	175 x 140	140 x 105	15	1.760

\* rim made of grey cast iron

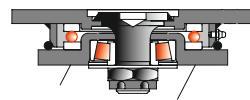

## Precision heavy-duty swivel castor brackets with a load capacity of up to 1,760 kg

Housings in precise highly stable welded steel construction. Swivel head with a high quality thrust ball bearing and a tapered roller bearing for the guidance of the kingpin. All bearing parts dust and splash proof. ALLSTOP total locking device on the non-trailing side of the housing, blocks rolling and swivel motion simultaneously.

ALLSTOP total locking device  
Code: 191 F PD-S/...



4-way directional lock  
Code: 191 PD-S/...4RIF



wheel and directional lock  
Code: 191 F PD-S/...4RIF



foot protection  
Code: ...PRO



PEVODYN® - PEVOELASTIC®  
PEVOHYAN®

Solid rubber  
wheels and castors

Electrically conductive  
wheels and castors

VULKOLLAN® - PEVOPIUR®  
PEVODYN® / -Soft

Stainless steel castors

Institutional  
wheels and castors

Conveyor/guiding  
rollers and ball units

Profile rollers

Pallet rollers









Press-on tyres

# Grey cast iron heavy-duty castors



Series 192 GU

Series 191 GU

								
Article code	mm	mm	mm	mm	mm	mm	mm	kg
191 GU/125/50/5	125	50	170	140 x 110	105 x 80	13	47	650
191 GU/150/50/5	150	50	200	140 x 110	105 x 80	13	55	700
191 GU/200/50/5	200	50	245	140 x 110	105 x 80	13	60	1.000
191 GU/250/60/5	250	60	305	175 x 140	140 x 105	15	75	1.350
191 GU/300/60/5	300	60	355	175 x 140	140 x 105	15	85	1.500

## Heavy-duty swivel castors with grey cast iron wheels

Grey cast iron wheels with ball bearings (/5).

							
Article code	mm	mm	mm	mm	mm	mm	kg
192 GU/125/50/5	125	50	170	140 x 110	105 x 80	13	650
192 GU/150/50/5	150	50	200	140 x 110	105 x 80	13	700
192 GU/200/50/5	200	50	245	140 x 110	105 x 80	13	1.000
192 GU/250/60/5	250	60	305	175 x 140	140 x 105	15	1.350
192 GU/300/60/5	300	60	355	175 x 140	140 x 105	15	1.500

## Heavy-duty fixed castors

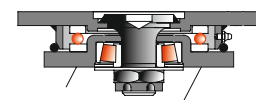

## Precision heavy-duty swivel castor brackets with a load capacity of up to 1,500 kg

Housings in precise highly stable welded steel construction. Swivel head with a high quality thrust ball bearing and a tapered roller bearing for the guidance of the kingpin. All bearing parts dust and splash proof. ALLSTOP total locking device on the non-trailing side of the housing, blocks rolling and swivel motion simultaneously.

ALLSTOP total locking device  
Code: 191 F GU/...



4-way directional lock  
Code: 191 GU/...4RIF\*



wheel and directional lock  
Code: 191 F GU/...4RIF



foot protection  
Code: ...PRO





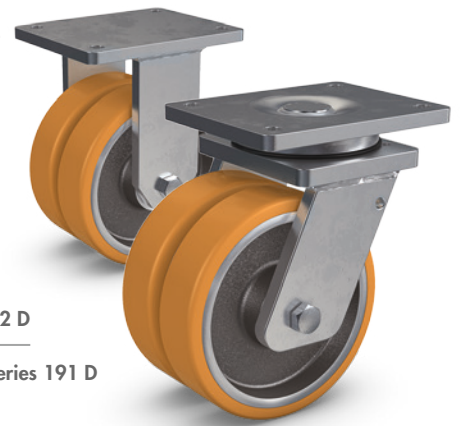





# PE·VO·PUR® heavy-duty castors





Series 192 D

Series 191 D

 Article code	 mm	 mm	 mm	 mm	 mm	 mm	 mm	 kg
191 D/125/50/5	125	2 x 50	180	175 x 140	140 x 105	15	49	1.100
191 D/150/50/5	150	2 x 50	210	200 x 160	160 x 120	15	50	1.350
191 D/200/50/5	200	2 x 50	260	200 x 160	160 x 120	15	60	2.000
191 D/250/60/5	250	2 x 60	320	250 x 200	210 x 160	19	70	2.700
191 D/250/80/5	250	2 x 80	320	250 x 200	210 x 160	19	70	3.600
191 D/300/80/5	300	2 x 80	380	250 x 200	210 x 160	19	80	4.300

## Heavy-duty twin wheel swivel castors with PEVOPUR® wheels

Wheels series 178 PUR with ball bearings (/5), see page 93.

 Article code	 mm	 mm	 mm	 mm	 mm	 mm	 kg
192 D/125/50/5*	125	2 x 50	180	175 x 140	140 x 105	15	1.100
192 D/150/50/5	150	2 x 50	210	200 x 160	160 x 120	15	1.350
192 D/200/50/5	200	2 x 50	260	200 x 160	160 x 120	15	2.000
192 D/250/60/5	250	2 x 60	320	250 x 200	210 x 160	19	2.700
192 D/250/80/5*	250	2 x 80	320	250 x 200	210 x 160	19	3.600
192 D/300/80/5*	300	2 x 80	380	250 x 200	210 x 160	19	4.300

\* Plate alignment: Long side is parallel with wheel axle.

## Heavy-duty twin wheel fixed castors

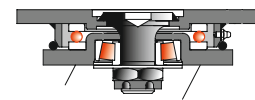

## Precision heavy-duty swivel castor brackets with a load capacity of up to 4,300 kg

Housings in precise highly stable welded steel construction. Swivel head with a high quality thrust ball bearing and a tapered roller bearing for the guidance of the kingpin. All bearing parts dust and splash proof. Wheel locking on the non-trailing side of the housing.

ALLSTOP total locking device  
Code: 191 D RF/...



4-way directional lock  
Code: 191 D/...4RIF



wheel and directional lock  
Code: 191 D RF/...4RIF



foot protection  
Code: ...PRO



PEVOPUR® - PEVOTHA®

Solid rubber wheels and castors

Electrically conductive wheels and castors

VULKOLLAN® - PEVOPUR® PEVODYN® - Soft

Stainless steel castors

Institutional wheels and castors

Conveyor/guiding rollers and ball units

Profile rollers

Pallet rollers

Press-on tyres

# PE·VO·DYN®-Soft heavy-duty castors

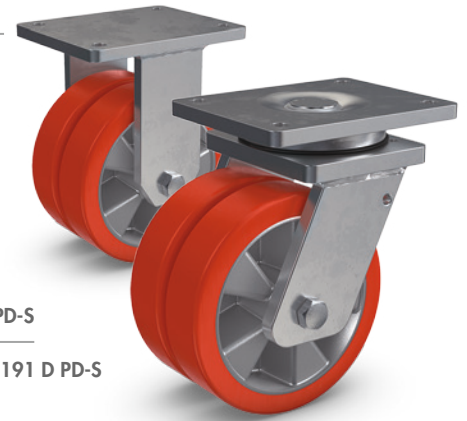

Series 192 D PD-S

Series 191 D PD-S

Article code	mm	mm	mm	mm	mm	mm	mm	kg
191 D PD-S/125/50/5	125	2 x 50	180	175 x 140	140 x 105	15	49	900
191 D PD-S/150/50/5	150	2 x 50	210	200 x 160	160 x 120	15	50	1.100
191 D PD-S/200/50/5	200	2 x 50	260	200 x 160	160 x 120	15	60	1.320
191 D PD-S/250/60/5 <sup>1</sup>	250	2 x 60	320	250 x 200	210 x 160	19	70	2.200
191 D PD-S/250/80/5 <sup>1</sup>	250	2 x 80	320	250 x 200	210 x 160	19	70	2.920
191 D PD-S/300/80/5 <sup>1</sup>	300	2 x 80	380	250 x 200	210 x 160	19	80	3.520

## Heavy-duty twin wheel swivel castors with PEVODYN®-SOFT wheels

Wheels series 183 ALU PD-S/178 PD-S with ball bearings (1/5), see page 92.

Article code	mm	mm	mm	mm	mm	mm	kg
192 D PD-S/125/50/5 <sup>2</sup>	125	2 x 50	180	175 x 140	140 x 105	15	900
192 D PD-S/150/50/5	150	2 x 50	210	200 x 160	160 x 120	15	1.100
192 D PD-S/200/50/5	200	2 x 50	260	200 x 160	160 x 120	15	1.320
192 D PD-S/250/60/5 <sup>1</sup>	250	2 x 60	320	250 x 200	210 x 160	19	2.200
192 D PD-S/250/80/5 <sup>1,2</sup>	250	2 x 80	320	250 x 200	210 x 160	19	2.920
192 D PD-S/300/80/5 <sup>1,2</sup>	300	2 x 80	380	250 x 200	210 x 160	19	3.520

<sup>1</sup> rim made of grey cast iron

<sup>2</sup> Plate alignment: Long side is parallel with wheel axle.

## Heavy-duty twin wheel fixed castors

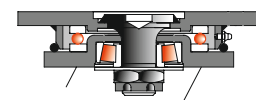

## Precision heavy-duty swivel castor brackets with a load capacity of up to 3,520 kg

Housings in precise highly stable welded steel construction. Swivel head with a high quality thrust ball bearing and a tapered roller bearing for the guidance of the kingpin. All bearing parts dust and splash proof. Wheel locking on the non-trailing side of the housing.

wheel locking device  
Code: 191 D RF PD-S/...



4-way directional lock  
Code: 191 D PD-S/...4RIF



wheel and directional lock  
Code: 191 D RF PD-S/...4RIF



foot protection  
Code: ...PRO

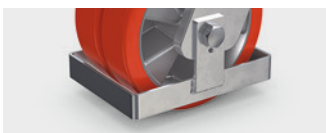

# PE·VO·PUR® heavy-duty castors









Series 196









Series 195

## Heavy-duty swivel castors with PEVOPUR® wheels

Wheels series 178 PUR with ball bearings (1/5), see page 93.

								
Article code	mm	mm	mm	mm	mm	mm	mm	kg
195/150/060/5	150	60	217	175 x 140	140 x 105	13	49	800
195/200/075/5	200	75	264	175 x 140	140 x 105	13	60	1.350
195/250/075/5	250	75	314	175 x 140	140 x 105	13	71	1.700
195/300/075/5	300	75	365	175 x 140	140 x 105	13	83	2.000
195/400/125/5	400	125	510	270 x 250	230 x 210	17	114	4.000

## Heavy-duty fixed castors

							
Article code	mm	mm	mm	mm	mm	mm	kg
196/150/060/5	150	60	217	175 x 140	140 x 105	13	800
196/200/075/5	200	75	264	175 x 140	140 x 105	13	1.350
196/250/075/5	250	75	314	175 x 140	140 x 105	13	1.700
196/300/075/5	300	75	365	175 x 140	140 x 105	13	2.000
196/400/125/5	400	125	510	270 x 250	230 x 210	17	4.000

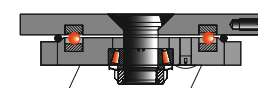

## Precision heavy-duty swivel castor brackets with a load capacity of up to 4,000 kg

Housings in precise highly stable welded steel construction. Swivel head with a high quality thrust ball bearing and a tapered roller bearing for the guidance of the kingpin. All bearing parts dust and splash proof. Wheel locking on the non-trailing side of the housing.

wheel locking device  
Code: 195 RF/...



4-way directional lock  
Code: 195/...4RIF



wheel and directional lock  
Code: 195 RF/...4RIF



foot protection  
Code: ...PRO



# VULKOLLAN®

## heavy-duty castors

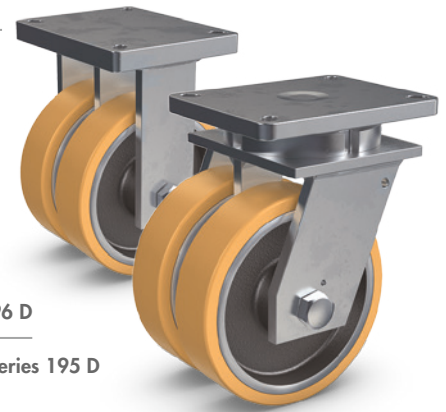

Series 196 D

Series 195 D

Article code	mm	mm	mm	mm	mm	mm	mm	kg
195 D/100/50/5	100	2 x 50	175	200 x 160	170 x 120/160 x 130	13	33	900
195 D/125/50/5	125	2 x 50	200	200 x 160	170 x 120/160 x 130	13	37	1.100
195 D/150/50/5	150	2 x 50	225	200 x 160	170 x 120/160 x 130	13	42	1.350
195 D/200/50/5	200	2 x 50	270	200 x 160	170 x 120/160 x 130	13	50	2.000
195 D/250/50/5	250	2 x 50	325	200 x 160	170 x 130/160 x 120	13	62	2.200
195 D/250/75/5	250	2 x 75	365	270 x 250	230 x 210/210 x 160	17	82	3.400
195 D/300/75/5	300	2 x 75	415	270 x 250	230 x 210/210 x 160	17	93	4.000
195 D/400/75/5	400	2 x 75	485	270 x 250	230 x 210/210 x 160	17	110	5.000

### Heavy-duty twin wheel swivel castors with VULKOLLAN® wheels

Wheels series 178 with ball bearings (/5), see page 94.

Article code	mm	mm	mm	mm	mm	mm	kg
196 D/100/50/5	100	2 x 50	175	200 x 160	170 x 120/160 x 130	13	900
196 D/125/50/5	125	2 x 50	200	200 x 160	170 x 120/160 x 130	13	1.100
196 D/150/50/5	150	2 x 50	225	200 x 160	170 x 120/160 x 130	13	1.350
196 D/200/50/5	200	2 x 50	270	200 x 160	170 x 120/160 x 130	13	2.000
196 D/250/50/5	250	2 x 50	325	200 x 160	170 x 130/160 x 120	13	2.200
196 D/250/75/5	250	2 x 75	365	270 x 250	230 x 210/210 x 160	17	3.400
196 D/300/75/5	300	2 x 75	415	270 x 250	230 x 210/210 x 160	17	4.000
196 D/400/75/5	400	2 x 75	485	270 x 250	230 x 210/210 x 160	17	5.000

### Heavy-duty twin wheel fixed castors

### Precision heavy-duty swivel castor brackets with a load capacity of up to 5,000 kg

Housings in precise highly stable welded steel construction. Swivel head with a high quality thrust ball bearing and a tapered roller bearing for the guidance of the kingpin. All bearing parts dust and splash proof. Wheel locking on the non-trailing side of the housing.

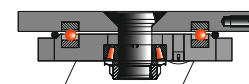

wheel locking device  
Code: 195 D RF/...



4-way directional lock  
Code: 195 D/...4RIF



wheel and directional lock  
Code: 195 D RF/...4RIF



foot protection  
Code: ...PRO



PEVOPUR® - PEVOTHA®

Solid rubber wheels and castors

Electrically conductive wheels and castors

VULKOLLAN® - PEVOPUR® PEVODYN® - Soft

Stainless steel castors

Institutional wheels and castors

Conveyor/guiding rollers and ball units

Profile rollers









Pallet rollers

Press-on tyres

# PE·VO·PUR® STAGE-SWIVEL



Series 37 TRI PUR

Article code	 mm	 mm	 mm	 mm	 mm	 mm	 mm	 kg
37 TRI PUR 035/27/5	35	27	78	115 x 85	80 x 55	259	9	250
37 TRI PUR 060/40/5*	60	40	125	130 x 130	105 x 105	334	11	1.000
37 TRI PUR 080/32/5	80	32	139	138 x 109	105 x 80	342	11	360
37 TRI PUR 100/40/5	100	40	160	138 x 109	105 x 80	432	11	600
37 TRI PUR 125/40/5*	125	40	200	130 x 130	105 x 105	494	11	2.000
37 TRI PUR 125/50/5*	125	50	229	250 x 210	210 x 160	519	18	3.000

\* twin wheels swivel castors

## STAGE-SWIVEL with PEVOPUR® wheels

STAGE-SWIVEL was originally developed for stage equipment and is today used in a wide range of different industries to solve challenging transportation tasks. STAGE-SWIVEL is equipped with our proven PEVOPUR® wheels and enables the swivel-free transportation of heavy loads. Thanks to the special design and additional stable thrust block, starting resistance and rolling resistance are significantly reduced.



PEVOPUR® - PEVOPLASTIC®  
PEVOTHA®

Solid rubber  
wheels and castors

Electrically conductive  
wheels and castors

VULVOLAN® - PEVOPUR®  
PEVODVM® - Soft

Stainless steel castors

Institutional  
wheels and castors

Conveyor/guiding  
rollers and ball units

Profile rollers

Pallet rollers

Press-on tyres



# PE·VO·LON®/PE·VO·THAN® stainless steel castors



PEVOLON® - PEVOPLASTIC®  
PEVOTHAN®

Solid rubber  
wheels and castors

Electrically conductive  
wheels and castors

VULKOLLAN® - PEVOPUR®  
PEVODYN® / -Soft

Stainless steel castors

Institutional  
wheels and castors

Conveyor/guiding  
rollers and ball units

Profile rollers

Pallet rollers

Press-on tyres

# PE·VO·LON®/PE·VO·THAN®

## stainless steel product overview

### Stainless steel

#### CASTORS

We produce stainless steel castor systems with the wheel materials PEVOLON®, PEVOTHAN® and thermoplastic rubber. These were specially developed for wet areas and areas with special hygiene requirements.

Compact brake systems offer long-lasting, secure locking for all areas of application. The dimensions fulfil to the standards of the European manufacturers of castors.



Series 67 NI  
Series 68 NI  
60 - 100 kg  
[Page 116](#)



Series 67 PU NI  
Series 68 PU NI  
40 - 125 kg  
[Page 117](#)



Series VL  
Series VB  
150 - 400 kg  
[Page 118 - 119](#)



Series WL NI  
Series WB NI  
300 - 750 kg  
[Page 120](#)



Series 31 PU NI  
Series 32 PU NI  
100 - 400 kg  
[Page 121 - 122](#)



Series 31 PS NI  
Series 32 PS NI  
80 - 300 kg  
[Page 123 - 124](#)



Series WL PU NI  
Series WB PU NI  
120 - 500 kg  
[Page 125](#)



Series XL  
Series XB  
450 - 550 kg  
[Page 126](#)



Series TL NI  
Series TB NI  
700 - 1.200 kg  
[Page 127](#)

# Stainless steel institutional castors

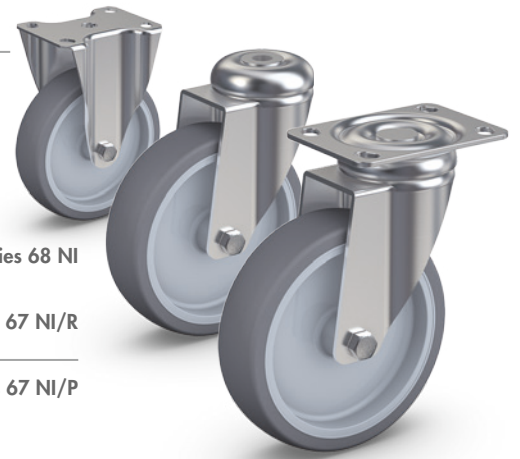

Series 68 NI

Series 67 NI/R

Series 67 NI/P

Article code	mm	mm	mm	mm	mm	mm	mm	mm	kg
67 NI/075/25/1/P	75	25	107	95 x 70	75 x 45/72 x 52	9	-	33	60
67 NI/100/32/1/P	100	32	135	95 x 70	75 x 45/72 x 52	9	-	41	80
67 NI/125/32/1/P	125	32	161	95 x 70	75 x 45/72 x 52	9	-	39	100
67 NI/075/30/5R/P	75	30	107	95 x 70	75 x 45/72 x 52	9	-	33	60
67 NI/100/32/5R/P	100	32	135	95 x 70	75 x 45/72 x 52	9	-	41	80
67 NI/125/32/5R/P	125	32	161	95 x 70	75 x 45/72 x 52	9	-	39	100
67 NI/075/25/1/R	75	25	104	-	-	-	10	33	60
67 NI/100/32/1/R	100	32	132	-	-	-	12	41	80
67 NI/125/32/1/R	125	32	158	-	-	-	12	39	100
67 NI/075/30/5R/R	75	30	104	-	-	-	10	33	60
67 NI/100/32/5R/R	100	32	132	-	-	-	12	41	80
67 NI/125/32/5R/R	125	32	158	-	-	-	12	39	100

Fixing devices for institutional swivel castors with bold hole fitting(/R), see page 127.

Article code	mm	mm	mm	mm	mm	mm	kg
68 NI/075/25/1/P	75	25	107	95 x 77	75 x 45/72 x 52	9	60
68 NI/100/32/1/P	100	32	135	95 x 77	75 x 45/72 x 52	9	80
68 NI/125/32/1/P	125	32	161	95 x 77	75 x 45/72 x 52	9	100
68 NI/075/30/5R/P	75	30	107	95 x 77	75 x 45/72 x 52	9	60
68 NI/100/32/5R/P	100	32	135	95 x 77	75 x 45/72 x 52	9	80
68 NI/125/32/5R/P	125	32	161	95 x 77	75 x 45/72 x 52	9	100

## Stainless steel institutional fixed castors

Matching the swivel castors with top plate (/P).

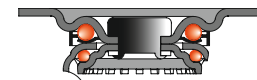

## Institutional swivel castor brackets with a load capacity of up to 100 kg

Housings made of polished stainless steel. Swivel head with double ball bearing and riveted kingpin. Available with either plate (P) or bolt hole (R) fitting. ALLSTOP total locking device on the trailing side of the housing, blocks rolling and swivel motion simultaneously.

ALLSTOP total locking device  
Code: 67 F NI/.../P

single bolt hole/total lock  
Code: 67 F NI/.../R



# PE·VO·THAN® stainless steel institutional castors



Series 68 PU NI

Series 67 PU NI/R

Series 67 PU NI/P

## Stainless steel institutional swivel castors with PEVO·THAN® wheels

Wheels series 85 PU with plain bearing (/1) or stainless steel ball bearing (/5R), see page 130.

Article code	mm	mm	mm	mm	mm	mm	mm	mm	kg
67 PU NI/050/18/1/P	50	18	71	60 x 60	46 x 46/38 x 38	6	–	21	40
67 PU NI/075/24/1/P	75	24	107	95 x 70	75 x 45/72 x 52	9	–	33	60
67 PU NI/100/30/1/P	100	30	135	95 x 70	75 x 45/72 x 52	9	–	41	100
67 PU NI/125/30/1/P	125	30	161	95 x 70	75 x 45/72 x 52	9	–	39	125
67 PU NI/075/24/5R/P	75	24	107	95 x 70	75 x 45/72 x 52	9	–	33	60
67 PU NI/100/30/5R/P	100	30	135	95 x 70	75 x 45/72 x 52	9	–	41	100
67 PU NI/125/30/5R/P	125	30	161	95 x 70	75 x 45/72 x 52	9	–	39	125
67 PU NI/050/18/1/R	50	18	69	–	–	–	11	23	40
67 PU NI/075/24/1/R	75	24	104	–	–	–	10	33	60
67 PU NI/100/30/1/R	100	30	132	–	–	–	12	41	100
67 PU NI/125/30/1/R	125	30	158	–	–	–	12	39	125
67 PU NI/075/24/5R/R	75	24	104	–	–	–	10	33	60
67 PU NI/100/30/5R/R	100	30	132	–	–	–	12	41	100
67 PU NI/125/30/5R/R	125	30	158	–	–	–	12	39	125

Fixing devices for institutional swivel castors with bold hole fitting(/R), see page 127.

Article code	in mm	in mm	in mm	in mm	in mm	in mm	in kg
68 PU NI/050/18/1/P	50	18	71	55 x 55	46 x 46/38 x 38	6	40
68 PU NI/075/24/1/P	75	24	107	95 x 77	75 x 45/72 x 52	9	60
68 PU NI/100/30/1/P	100	30	135	95 x 77	75 x 45/72 x 52	9	100
68 PU NI/125/30/1/P	125	30	161	95 x 77	75 x 45/72 x 52	9	125
68 PU NI/075/24/5R/P	75	24	107	95 x 77	75 x 45/72 x 52	9	60
68 PU NI/100/30/5R/P	100	30	135	95 x 77	75 x 45/72 x 52	9	100
68 PU NI/125/30/5R/P	125	30	161	95 x 77	75 x 45/72 x 52	9	125

## Institutional fixed castors

Matching the swivel castors with top plate (/P).

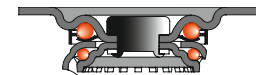

## Institutional swivel castor brackets with a load capacity of up to 125 kg

Housings made of polished stainless steel. Swivel head with double ball bearing and riveted kingpin. Available with either plate (P) or bolt hole (R) fitting. ALLSTOP total locking device on the trailing side of the housing, blocks rolling and swivel motion simultaneously.

ALLSTOP total locking device  
Code: 67 F PU NI/.../P

single bolt hole/total lock  
Code: 67 F PU NI/.../R



PEVO·THAN®  
PEVO·THAN®  
Solid rubber wheels and castors  
Electrically conductive wheels and castors  
VULKOLLAN® • PEVO·THAN®  
PEVO·THAN® - Soft  
Stainless steel castors  
Institutional wheels and castors  
Conveyor/guiding rollers and ball units  
Profile rollers  
Pallet rollers  
Press-on tyres











# PE·VO·LON®

## stainless steel industrial castors











Series VB/1

Series VL/1

									
Article code	mm	mm	mm	mm	mm	mm	mm	mm	kg
VL 080/35/1 L	80	35	108	105 x 85	80 x 60	9	38	150	
VL 100/34/1 L	100	34	128	105 x 85	80 x 60	9	38	150	
VL 125/40/1 L	125	40	155	105 x 85	80 x 60	9	45	150	
VL 125/40/1	125	40	161	135 x 110	105 x 80	11	55	300	
VL 150/42/1	150	42	192	135 x 110	105 x 80	11	55	400	
VL 160/40/1	160	40	197	135 x 110	105 x 80	11	55	400	
VL 200/50/1	200	50	237	135 x 110	105 x 80	11	55	400	

### Stainless steel industrial swivel castors with PEVOLON® wheels (plain bearing)

Wheels series B with plain bearing (/1), see page 39.

								
Article code	mm	mm	mm	mm	mm	mm	mm	kg
VB 080/35/1 L	80	35	108	105 x 85	80 x 60	9	150	
VB 100/34/1 L	100	34	128	105 x 85	80 x 60	9	150	
VB 125/40/1 L	125	40	155	105 x 85	80 x 60	9	150	
VB 125/40/1	125	40	161	135 x 110	105 x 80	11	300	
VB 150/42/1	150	42	192	135 x 110	105 x 80	11	400	
VB 160/40/1	160	40	197	135 x 110	105 x 80	11	400	
VB 200/50/1	200	50	237	135 x 110	105 x 80	11	400	

### Stainless steel industrial fixed castors

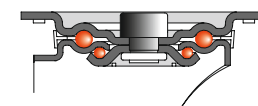

### Industrial swivel castor brackets with a load capacity of up to 400 kg

Housings made of pressed stainless steel. Swivel head with double ball bearings, dust and splash proof, with riveted kingpin. ALLSTOP total locking device on the trailing side of the housing, blocks rolling and swivel motion simultaneously.

ALLSTOP total locking device  
Code: VLF...



single bolt hole  
Code: VL.../...R



single bolt hole/total lock  
Code: VLF.../...R



stem fitting  
Code: VLZ...



stem fitting/total locking device  
Code: VLFZ...



PEVOLON® - PEVOLASTIC® - PEVOTHAN®  
Solid rubber wheels and castors  
Electrically conductive wheels and castors  
VULKOLLAN® - PEVOPUR® - PEVODYM® - Soft  
Stainless steel castors  
Institutional wheels and castors  
Conveyor/guiding rollers and ball units  
Profile rollers  
Pallet rollers  
Press-on tyres

# PE·VO·LON®

## stainless steel industrial castors



Series VB/3

Series VL/3

Article code	mm	mm	mm	mm	mm	mm	mm	kg
VL 080/30/3R L	80	30	108	105 x 85	80 x 60	9	38	150
VL 100/34/3R L	100	34	128	105 x 85	80 x 60	9	38	150
VL 125/40/3R L	125	40	155	105 x 85	80 x 60	9	45	150
VL 125/40/3R	125	40	161	135 x 110	105 x 80	11	55	300
VL 150/42/3R	150	42	192	135 x 110	105 x 80	11	55	225
VL 160/40/3R	160	40	197	135 x 110	105 x 80	11	55	400
VL 200/50/3R	200	50	237	135 x 110	105 x 80	11	55	400

### Stainless steel industrial swivel castors with PEVOLON® wheels (stainless roller bearing)

Wheels series B with stainless roller bearing (/3R).

Article code	mm	mm	mm	mm	mm	mm	kg
VB 080/30/3R L	80	30	108	105 x 85	80 x 60	9	150
VB 100/34/3R L	100	34	128	105 x 85	80 x 60	9	150
VB 125/40/3R L	125	40	155	105 x 85	80 x 60	9	150
VB 125/40/3R	125	40	161	135 x 110	105 x 80	11	300
VB 150/42/3R	150	42	192	135 x 110	105 x 80	11	225
VB 160/40/3R	160	40	197	135 x 110	105 x 80	11	400
VB 200/50/3R	200	50	237	135 x 110	105 x 80	11	400

### Stainless steel industrial fixed castors

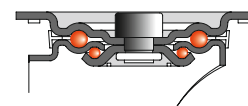

### Industrial swivel castor brackets with a load capacity of up to 400 kg

Housings made of pressed stainless steel. Swivel head with double ball bearings, dust and splash proof, with riveted kingpin. ALLSTOP total locking device on the trailing side of the housing, blocks rolling and swivel motion simultaneously.

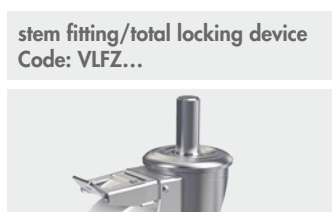
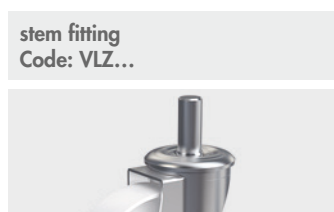
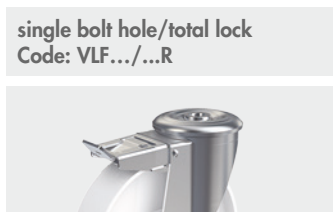
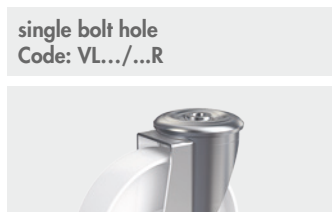
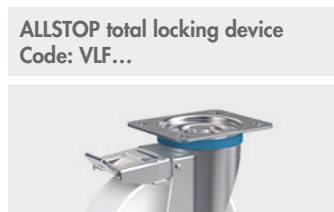

PEVOLON® - PEVOPLASTIC®  
PEVOTHA®

Solid rubber  
wheels and castors

Electrically conductive  
wheels and castors

VULVOLAN® - PEVOPLUR®  
PEVODYN® - Soft

Stainless steel castors

Institutional  
wheels and castors

Conveyor/guiding  
rollers and ball units

Profile rollers

Puller rollers

Press-on tyres

# PE·VO·LON®

## stainless steel industrial castors



Series WB NI

Series WL NI

Article code	mm	mm	mm	mm	mm	mm	mm	kg
WL NI/080/35/1 L	80	35	118	105 x 85	80 x 60	9	40	300
WL NI/100/40/1 L	100	40	140	105 x 85	80 x 60	9	45	350
WL NI/100/50/1	100	50	148	135 x 110	105 x 80	11	50	600
WL NI/125/40/1 L	125	40	165	105 x 85	80 x 60	9	45	350
WL NI/125/50/1	125	50	178	135 x 110	105 x 80	11	50	700
WL NI/150/50/1	150	50	205	135 x 110	105 x 80	11	50	750
WL NI/200/50/1	200	50	250	135 x 110	105 x 80	11	55	750

### Stainless steel industrial swivel castors with PEVOLON® wheels

Wheels series A with plain bearing (/1), see page 36.

Article code	mm	mm	mm	mm	mm	mm	kg
WB NI/080/35/1 L	80	35	118	105 x 85	80 x 60	9	300
WB NI/100/40/1 L	100	40	140	105 x 85	80 x 60	9	350
WB NI/100/50/1	100	50	148	135 x 110	105 x 80	11	600
WB NI/125/40/1 L	125	40	165	105 x 85	80 x 60	9	350
WB NI/125/50/1	125	50	178	135 x 110	105 x 80	11	700
WB NI/150/50/1	150	50	205	135 x 110	105 x 80	11	750
WB NI/200/50/1	200	50	250	135 x 110	105 x 80	11	750

### Stainless steel industrial fixed castors

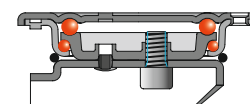

### Industrial swivel castor brackets with a load capacity of up to 750 kg

Housings made of strong pressed stainless steel. Swivel head with double ball bearings, dust and splash proof. Without kingpin. With grease nipple. ALLSTOP total locking device on the trailing side of the housing, blocks rolling and swivel motion simultaneously.

ALLSTOP total locking device  
Code: WLF NI/...



# PE·VO·THAN®

## stainless steel industrial castors

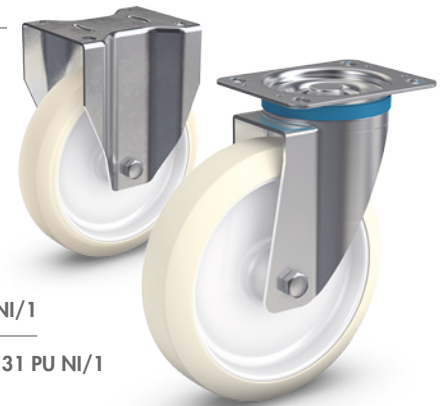

Series 32 PU NI/1

Series 31 PU NI/1

Article code	mm	mm	mm	mm	mm	mm	mm	kg
31 PU NI/080/35/1 L	80	35	108	105 x 85	80 x 60	9	38	100
31 PU NI/100/34/1 L	100	34	128	105 x 85	80 x 60	9	38	140
31 PU NI/125/37/1 L	125	37	155	105 x 85	80 x 60	9	45	180
31 PU NI/150/45/1	150	45	192	135 x 110	105 x 80	11	55	225
31 PU NI/160/50/1	160	50	197	135 x 110	105 x 80	11	55	250
31 PU NI/200/50/1	200	50	237	135 x 110	105 x 80	11	55	400

### Stainless steel industrial swivel castors with PEVOTHAN® wheels (plain bearing)

Wheels series 89 PU with plain bearing (/1), see page 51.

Article code	mm	mm	mm	mm	mm	mm	kg
32 PU NI/080/35/1 L	80	35	108	105 x 85	80 x 60	9	100
32 PU NI/100/34/1 L	100	34	128	105 x 85	80 x 60	9	140
32 PU NI/125/37/1 L	125	37	155	105 x 85	80 x 60	9	180
32 PU NI/150/45/1	150	45	192	135 x 110	105 x 80	11	225
32 PU NI/160/50/1	160	50	197	135 x 110	105 x 80	11	250
32 PU NI/200/50/1	200	50	237	135 x 110	105 x 80	11	400

### Stainless steel industrial fixed castors

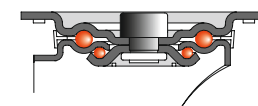

### Industrial swivel castor brackets with a load capacity of up to 400 kg

Housings made of pressed stainless steel. Swivel head with double ball bearings, dust and splash proof, with riveted kingpin. ALLSTOP total locking device on the trailing side of the housing, blocks rolling and swivel motion simultaneously.

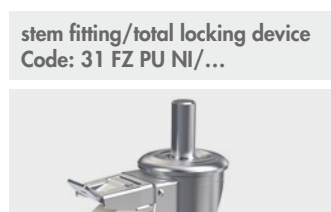
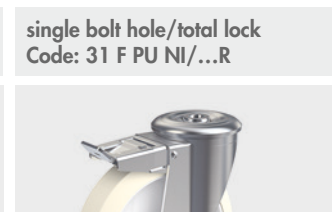

PEVONIP® • PEVOPLASTIC®  
PEVOTHAN®  
Solid rubber wheels and castors  
Electrically conductive wheels and castors  
VULVOLAN® • PEVOPIUR®  
PEVODIV® / -Soft  
Stainless steel castors  
Institutional wheels and castors  
Conveyor/guiding rollers and ball units  
Profile rollers  
Pallet rollers  
Press-on tyres



# PE·VO·THAN®

## stainless steel industrial castors

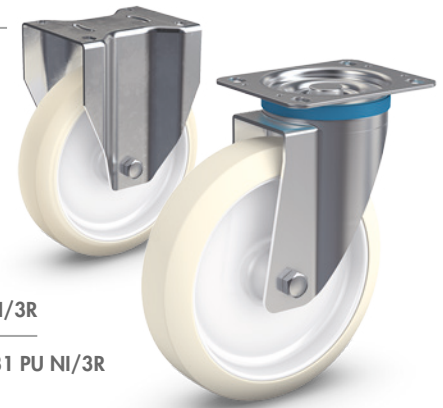

Series 32 PU NI/3R

Series 31 PU NI/3R

### Stainless steel industrial swivel castors with PEVOLOAN® wheels (stainless roller bearing)

Wheels series 89 PU with stainless roller bearing (/3R), see page 51.

Article code	mm	mm	mm	mm	mm	mm	mm	kg
31 PU NI/080/35/3R L	80	35	108	105 x 85	80 x 60	9	38	100
31 PU NI/100/34/3R L	100	34	128	105 x 85	80 x 60	9	38	140
31 PU NI/125/37/3R L	125	37	155	105 x 85	80 x 60	9	45	180
31 PU NI/150/45/3R	150	45	192	135 x 110	105 x 80	11	55	225
31 PU NI/160/50/3R	160	50	197	135 x 110	105 x 80	11	55	250
31 PU NI/200/50/3R	200	50	237	135 x 110	105 x 80	11	55	400

### Stainless steel industrial fixed castors

Article code	mm	mm	mm	mm	mm	mm	kg
32 PU NI/080/35/3R L	80	35	108	105 x 85	80 x 60	9	100
32 PU NI/100/34/3R L	100	34	128	105 x 85	80 x 60	9	140
32 PU NI/125/37/3R L	125	37	155	105 x 85	80 x 60	9	180
32 PU NI/150/45/3R	150	45	192	135 x 110	105 x 80	11	225
32 PU NI/160/50/3R	160	50	197	135 x 110	105 x 80	11	250
32 PU NI/200/50/3R	200	50	237	135 x 110	105 x 80	11	400

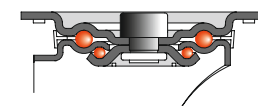

### Industrial swivel castor brackets with a load capacity of up to 400 kg

Housings made of pressed stainless steel. Swivel head with double ball bearings, dust and splash proof, with riveted kingpin. ALLSTOP total locking device on the trailing side of the housing, blocks rolling and swivel motion simultaneously.

ALLSTOP total locking device  
Code: 31 F PU NI/...



single bolt hole  
Code: 31 PU NI/...R



single bolt hole/total lock  
Code: 31 F PU NI/...R



stem fitting  
Code: 31 Z PU NI/...



stem fitting/total locking device  
Code: 31 FZ PU NI/...



# Stainless steel industrial castors

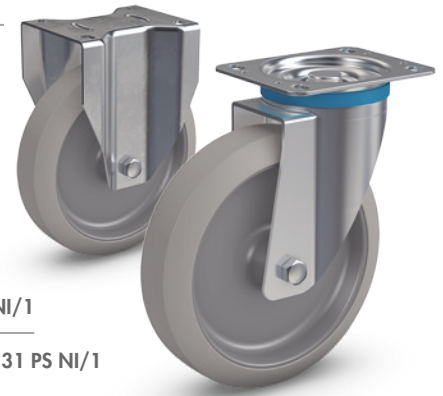

Series 32 PS NI/1

Series 31 PS NI/1

								
Article code	mm	mm	mm	mm	mm	mm	mm	kg
31 PS NI/080/35/1 L	80	35	108	105 x 85	80 x 60	9	38	80
31 PS NI/100/34/1 L	100	34	128	105 x 85	80 x 60	9	38	100
31 PS NI/125/37/1 L	125	37	155	105 x 85	80 x 60	9	45	120
31 PS NI/150/45/1	150	45	192	135 x 110	105 x 80	11	55	180
31 PS NI/160/50/1	160	50	197	135 x 110	105 x 80	11	55	200
31 PS NI/200/50/1	200	50	237	135 x 110	105 x 80	11	55	300

## Stainless steel industrial swivel castors with thermoplastic rubber wheels (plain bearing)

Wheels series 89 PS with plain bearing (/1), see page 61.

							
Article code	mm	mm	mm	mm	mm	mm	kg
32 PS NI/080/35/1 L	80	35	108	105 x 85	80 x 60	9	80
32 PS NI/100/34/1 L	100	34	128	105 x 85	80 x 60	9	100
32 PS NI/125/37/1 L	125	37	155	105 x 85	80 x 60	9	120
32 PS NI/150/45/1	150	45	192	135 x 110	105 x 80	11	180
32 PS NI/160/50/1	160	50	197	135 x 110	105 x 80	11	200
32 PS NI/200/50/1	200	50	237	135 x 110	105 x 80	11	300

## Stainless steel industrial fixed castors

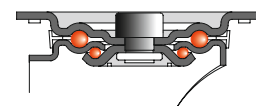

## Industrial swivel castor brackets with a load capacity of up to 300 kg

Housings made of pressed stainless steel. Swivel head with double ball bearings, dust and splash proof, with riveted kingpin. ALLSTOP total locking device on the trailing side of the housing, blocks rolling and swivel motion simultaneously.

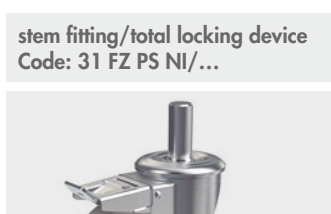
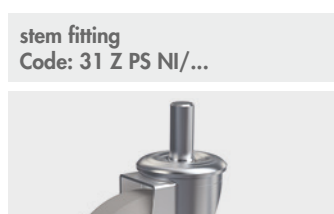
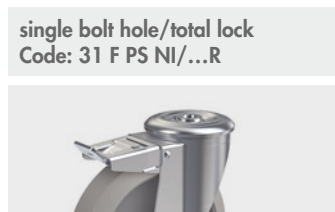
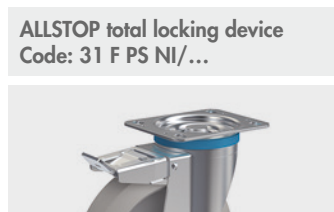

PEVOLOP® - PEVOLOP®  
PEVOTHA®  
Solid rubber wheels and castors  
Electrically conductive wheels and castors  
VULKOLLAN® - PEVOLOP®  
PEVODYN® - Soft  
Stainless steel castors  
Institutional wheels and castors  
Conveyor/guiding rollers and ball units  
Profile rollers  
Pallet rollers  
Press-on tyres

# Stainless steel industrial castors

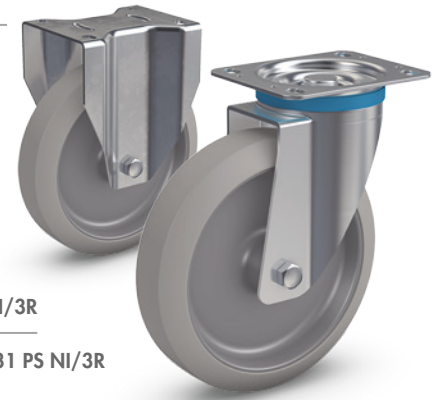

Series 32 PS NI/3R

Series 31 PS NI/3R

Article code	mm	mm	mm	mm	mm	mm	mm	kg
31 PS NI/080/35/3R L	80	35	108	105 x 85	80 x 60	9	38	80
31 PS NI/100/34/3R L	100	34	128	105 x 85	80 x 60	9	38	100
31 PS NI/125/37/3R L	125	37	155	105 x 85	80 x 60	9	45	120
31 PS NI/150/45/3R	150	45	192	135 x 110	105 x 80	11	55	180
31 PS NI/160/50/3R	160	50	197	135 x 110	105 x 80	11	55	200
31 PS NI/200/50/3R	200	50	237	135 x 110	105 x 80	11	55	300

## Stainless steel industrial swivel castors with thermoplastic rubber wheels (stainless roller bearing)

Wheels series 89 PS with stainless roller bearing (/3R), see page 61.

Article code	mm	mm	mm	mm	mm	mm	kg
32 PS NI/080/35/3R L	80	35	108	105 x 85	80 x 60	9	80
32 PS NI/100/34/3R L	100	34	128	105 x 85	80 x 60	9	100
32 PS NI/125/37/3R L	125	37	155	105 x 85	80 x 60	9	120
32 PS NI/150/45/3R	150	45	192	135 x 110	105 x 80	11	180
32 PS NI/160/50/3R	160	50	197	135 x 110	105 x 80	11	200
32 PS NI/200/50/3R	200	50	237	135 x 110	105 x 80	11	300

## Stainless steel industrial fixed castors

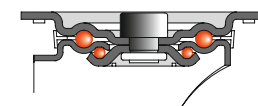

## Industrial swivel castor brackets with a load capacity of up to 300 kg

Housings made of pressed stainless steel. Swivel head with double ball bearings, dust and splash proof, with riveted kingpin. ALLSTOP total locking device on the trailing side of the housing, blocks rolling and swivel motion simultaneously.

ALLSTOP total locking device  
Code: 31 F PS NI/...



single bolt hole  
Code: 31 PS NI/...R



single bolt hole/total lock  
Code: 31 F PS NI/...R



stem fitting  
Code: 31 Z PS NI/...



stem fitting/total locking device  
Code: 31 FZ PS NI/...



# PE·VO·THAN®

## stainless steel industrial castors



Series WB PU NI

Series WL PU NI

### Stainless steel industrial swivel castors with PEVOTHAN® wheels

Wheels series 87 PU with plain bearing (/1), see page 52.

Article code	mm	mm	mm	mm	mm	mm	mm	kg
WL PU NI/080/35/1 L	80	35	118	105 x 85	80 x 60	9	40	120
WL PU NI/100/40/1 L	100	40	140	105 x 85	80 x 60	9	45	200
WL PU NI/125/45/1 L	125	45	165	105 x 85	80 x 60	9	45	250
WL PU NI/150/45/1	150	45	205	135 x 110	105 x 80	11	50	380
WL PU NI/200/50/1	200	50	250	135 x 110	105 x 80	11	55	500

### Stainless steel industrial fixed castors

Article code	mm	mm	mm	mm	mm	mm	kg
WB PU NI/080/35/1 L	80	35	118	105 x 85	80 x 60	9	120
WB PU NI/100/40/1 L	100	40	140	105 x 85	80 x 60	9	200
WB PU NI/125/45/1 L	125	45	165	105 x 85	80 x 60	9	250
WB PU NI/150/45/1	150	45	205	135 x 110	105 x 80	11	380
WB PU NI/200/50/1	200	50	250	135 x 110	105 x 80	11	500

ALLSTOP total locking device  
Code: WLF PU NI/...

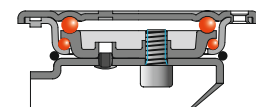

### Industrial swivel castor brackets with a load capacity of up to 500 kg

Housings made of strong pressed stainless steel. Swivel head with double ball bearings, dust and splash proof. Without kingpin. With grease nipple. ALLSTOP total locking device on the trailing side of the housing, blocks rolling and swivel motion simultaneously.









PEVOLON® • PEVOPLASTIC®  
PEVOTHAN®  
Solid rubber wheels and castors  
Electrically conductive wheels and castors  
VULKOLLAN® • PEVOPLUR® PEVODYN® / -Soft  
Stainless steel castors  
Institutional wheels and castors  
Conveyor/guiding rollers and ball units  
Profile rollers  
Pallet rollers  
Press-on tyres

# PE·VO·LON® stainless steel heavy-duty castors











Series XB

Series XL

								
Article code	mm	mm	mm	mm	mm	mm	mm	kg
XL 100/40/1	100	40	133	119 x 101	84 x 72	11	41	450
XL 125/50/1	125	50	164	140 x 110	105 x 80	13	50	550
XL 150/50/1	150	50	188	140 x 110	105 x 80	13	55	550
XL 200/50/1	200	50	242	140 x 110	105 x 80	13	58	550

## Stainless steel heavy-duty swivel castors with PEVOLON® wheels

With wheels series A with plain bearing (/1), see page 36.

							
Article code	mm	mm	mm	mm	mm	mm	kg
XB 100/40/1	100	40	133	119 x 101	84 x 72	11	450
XB 125/50/1	125	50	164	140 x 110	105 x 80	13	550
XB 150/50/1	150	50	188	140 x 110	105 x 80	13	550
XB 200/50/1	200	50	242	140 x 110	105 x 80	13	550

## Stainless steel heavy-duty industrial fixed castors

ALLSTOP total locking device  
Code: XLF...

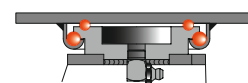

## Heavy-duty swivel castor brackets with a load capacity of up to 550 kg

Housings made of welded stainless steel. Swivel head with double ball bearings, dust and splash proof. Without kingpin. With grease nipple. ALLSTOP total locking device on the non-trailing side of the housing, blocks rolling and swivel motion simultaneously.

PEVOLON® - PEVOLASTIC®  
PEVOTHAN®  
Solid rubber wheels and castors  
Electrically conductive wheels and castors  
VULKOLLAN® - PEVOPUR®  
PEVODVM® / -Soft  
Stainless steel castors  
Institutional wheels and castors  
Conveyor/guiding rollers and ball units  
Profile rollers  
Pallet rollers  
Press-on tyres

# PE·VO·LON® stainless steel industrial castors



Series TB NI

Series TL NI

Article code	mm	mm	mm	mm	mm	mm	mm	kg
TL NI/125/50/1	125	50	176	140 x 110	105 x 80	12	45	700
TL NI/160/50/1	160	50	212	140 x 110	105 x 80	12	52	850
TL NI/200/50/1	200	50	250	140 x 110	105 x 80	12	58	1.200

## Stainless steel heavy-duty industrial swivel castors with PEVOLON® wheels

Wheels series A with plain bearing (/1), see page 36.

Article code	mm	mm	mm	mm	mm	mm	kg
TB NI/125/50/1	125	50	176	140 x 110	105 x 80	12	700
TB NI/160/50/1	160	50	212	140 x 110	105 x 80	12	850
TB NI/200/50/1	200	50	250	140 x 110	105 x 80	12	1.200

## Stainless steel heavy-duty industrial fixed castors

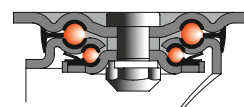

## Industrial swivel castor brackets with a load capacity of up to 1,200 kg

Housings made of extra strong pressed stainless steel. Swivel head with double ball bearing. Bearing shells made of hardened steel. Kingpin bolted and secured. ALLSTOP total locking device on the non-trailing side of the housing, blocks rolling and swivel motion simultaneously.

ALLSTOP total locking device  
Code: TLF NI...



Article code	Clamping range min mm	Clamping range max mm
69 K-R 20 NI	19,0	21,5
69 K-R 22 NI	21,5	24,0
69 K-R 24 NI	24,0	27,0
69 K-R 28 NI	27,0	30,0
69 K-R 32 NI	31,0	35,0
69 K-V 22 NI	21,5	24,0
69 K-V 25 NI	24,0	27,0
69 K-V 27 NI	27,0	30,0
69 K-V 32 NI	32,0	35,0
69 K-V 37 NI	36,0	40,0

## Fixing devices for institutional swivel castors with bolt hole fitting

Plastic expander for circular tubes (-R) or square tubes (-V).

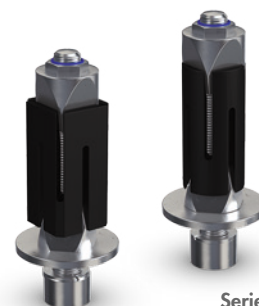

Series 69 K

PEVOLON® - PEVOPLASTIC®  
PEVOHAN®

Solid rubber  
wheels and castors

Electrically conductive  
wheels and castors

VULKOLLAN® - PEVOPLUR®  
PEVOVIM® / -Soft

Stainless steel castors

Institutional  
wheels and castors

Conveyor/guiding  
rollers and ball units

Profile rollers

Puller rollers

Press-on tyres

# Institutional wheels and castors

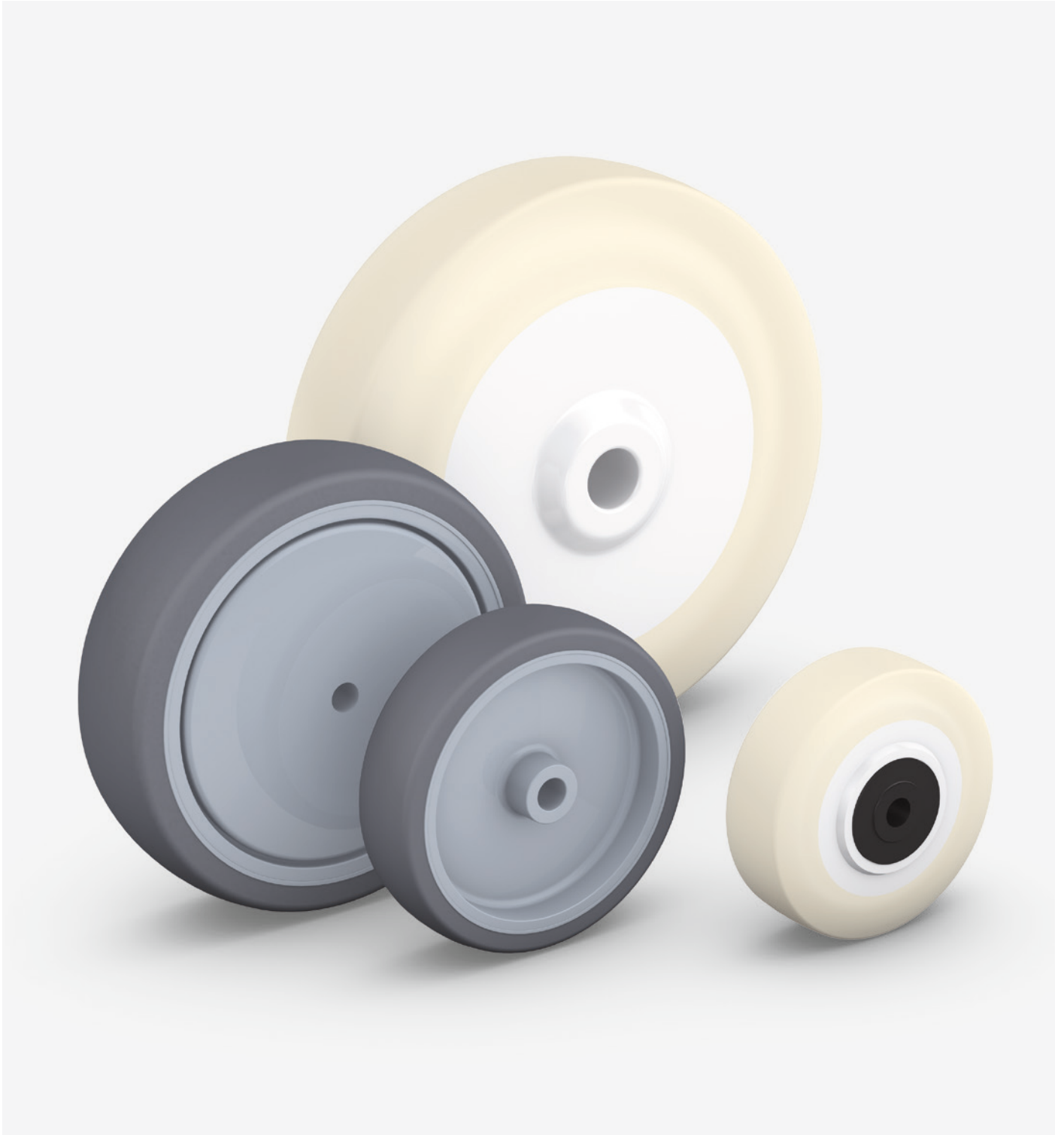

PEVOLON® • PEVOPLASTIC® PEVOTHA®	Solid rubber wheels and castors	Electrically conductive wheels and castors	VULKOLLAN® • PEVOPUR® PEVODYN® / -Soft	Stainless steel castors	Institutional wheels and castors	Conveyor/guiding rollers and ball units	Profile rollers	Pallet rollers	Press-on tyres
-------------------------------------	------------------------------------	---	---	-------------------------	-------------------------------------	--	-----------------	----------------	----------------

# Institutional wheels and castors product overview

## Institutional WHEELS AND CASTORS

Our extensive range of institutional castors completes our castor range for in-plant transportation.

The high-quality materials we use insure a long service life.

A wide range of mounting possibilities enable flexible installation.

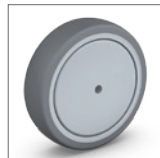

Series 85  
Series 85 PU  
40 - 125 kg  
[Page 130](#)



Series 67 /P  
Series 68 /P  
40 - 110 kg  
[Page 132](#)



Series 67 /R  
40 - 110 kg  
[Page 133](#)



Series 69 K-R  
Series 69 K-V  
[Page 133](#)



Series 67 PU  
Series 68 PU  
40 - 125 kg  
[Page 134](#)



Series 67 D  
Series 67 D PU  
60 - 80 kg  
[Page 135](#)





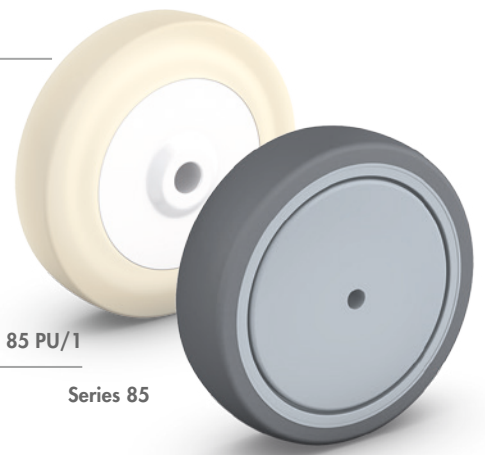



# Institutional wheels









Series 85 PU/1

Series 85

 Article code	 mm	 mm	 mm	 mm	 kg
85/050/018/1/6	50	18	21	6	40
85/050/018/1/8	50	18	22	8	40
85/075/024/1/8	75	24	27	8	60
85/100/032/1/12	100	32	39	12	100
85/125/032/1/12	125	32	39	12	100
85/150/032/1/12	150	32	35	12	110
85/050/018/5/6 FAD	50	18	22	6	40
85/075/024/5/6 FAD	75	24	28	6	60
85/100/032/5/8 FAD	100	32	36	8	100
85/150/032/5/8 FAD	150	32	36	8	110
85/075/030/5R/8 FAD	75	30	40	8	60
85/100/032/5R/8 FAD	100	32	36	8	100
85/125/032/5R/8 FAD	125	32	36	8	100
85/150/032/5R/8 FAD	150	32	36	8	110

FAD = thread guard

 Article code	 mm	 mm	 mm	 mm	 kg
85 PU/050/018/1/8	50	18	22	8	40
85 PU/075/024/1/8	75	24	28	8	60
85 PU/100/030/1/12	100	30	39	12	100
85 PU/125/030/1/12	125	30	39	12	125
85 PU/075/024/5/8	75	24	28	8	60
85 PU/100/030/5/8	100	30	36	8	100
85 PU/125/030/5/8	125	30	36	8	125
85 PU/075/024/5R/8	75	24	28	8	60
85 PU/100/030/5R/8	100	30	36	8	100
85 PU/125/030/5R/8	125	30	36	8	125

## Thermoplastic rubber wheels with plastic rim

Plastic rim with non-marking thermoplastic rubber tyre with plain bearing (/1), ball bearing (/5) or stainless ball bearing (/5R).

## PEVOTHAN® wheels

PEVOLON® rim with high-quality thermoplastic polyurethane tread with plain bearing (/1), ball bearings (/5) or stainless ball bearings (/5R).

PEVOLON® • PEVOTHAN®  
Solid rubber wheels and castors  
Electrically conductive wheels and castors  
VULKOLLAN® • PEVOPUR® PEVOTHAN® - Soft  
Stainless steel castors  
Institutional wheels and castors  
Conveyor/guiding rollers and ball units  
Profile rollers  
Pallet rollers  
Press-on tyres

# Institutional wheels

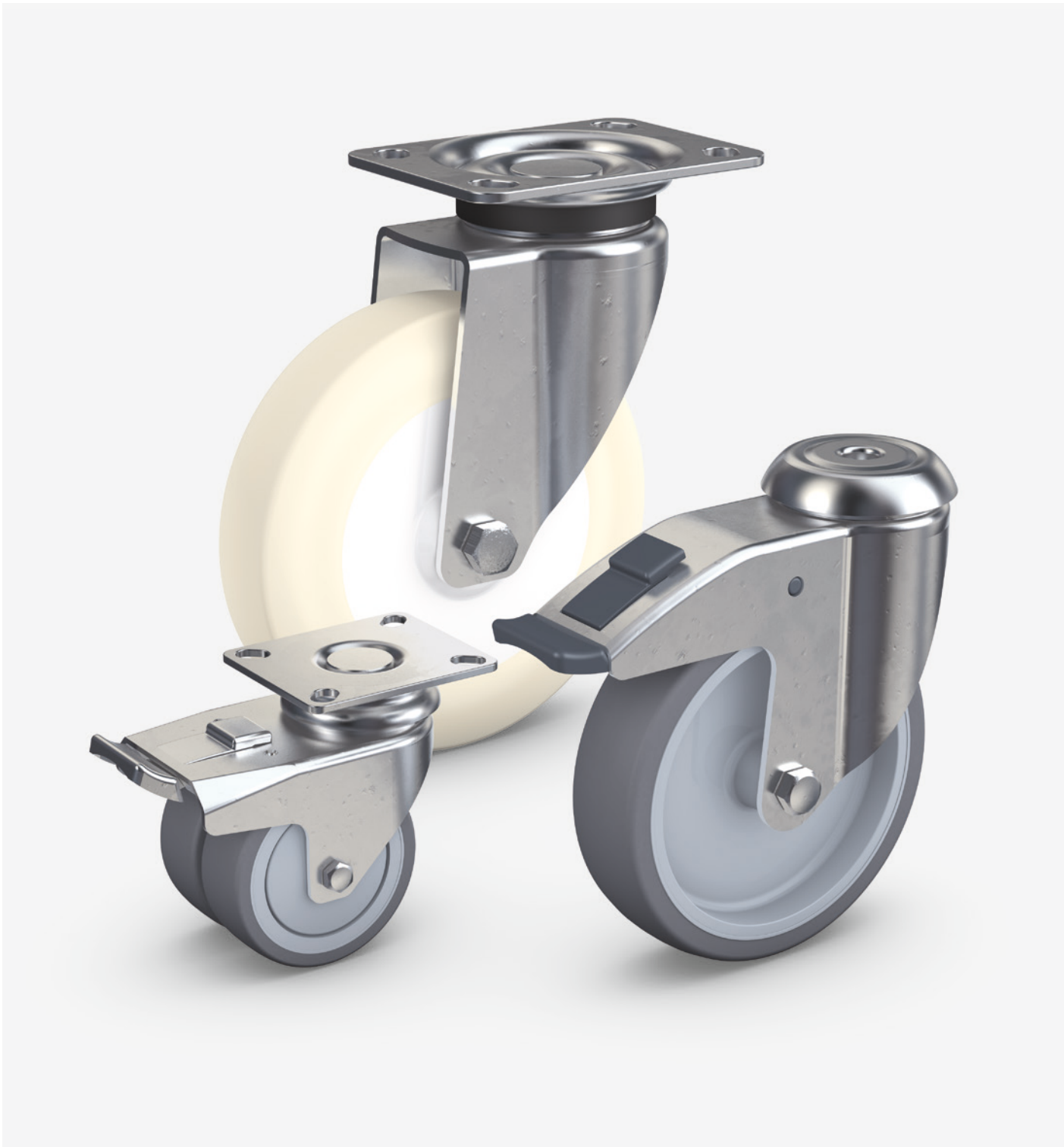

PEVOLON® • PEVOPLASTIC®  
PEVOTHA®

Solid rubber  
wheels and castors

Electrically conductive  
wheels and castors

VULKOLLAN® • PEVOPUR®  
PEVODYN® / -Soft

Stainless steel castors

Institutional  
wheels and castors

Conveyor/guiding  
rollers and ball units

Profile rollers

Pallet rollers

Press-on tyres

# Institutional wheels

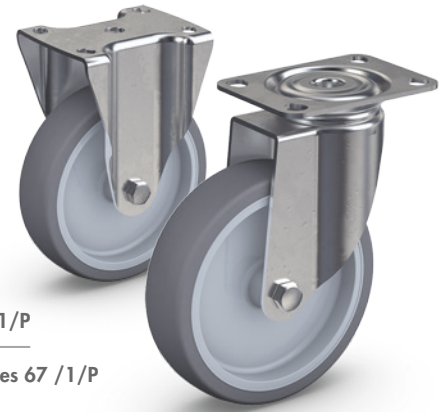

Series 68 /1/P

Series 67 /1/P

Article code	mm	mm	mm	mm	mm	mm	mm	kg
67/050/18/1/P	50	18	69	60 x 60	48 x 48/38 x 38	6	23	40
67/075/25/1/P	75	25	100	60 x 60	48 x 48/38 x 38	6	30	60
67/100/32/1/P	100	32	135	95 x 70	76 x 52/72 x 45	9	43	90
67/125/32/1/P	125	32	160	95 x 70	76 x 52/72 x 45	9	41	110
67/150/32/1/P	150	32	185	95 x 70	76 x 52/72 x 45	9	36	110
67/050/18/5/P FAD	50	18	69	60 x 60	46 x 46/40 x 40	6	25	40
67/075/25/5/P FAD	75	25	100	60 x 60	48 x 48/38 x 38	6	30	60
67/100/32/5/P FAD	100	32	135	95 x 70	76 x 52/72 x 45	9	43	90
67/125/32/5/P FAD	125	32	160	95 x 70	76 x 52/72 x 45	9	41	110
67/150/32/5/P FAD	150	32	185	95 x 70	76 x 52/72 x 45	9	36	110

## Institutional swivel castors with thermoplastic rubber wheels

Wheels series 85 with plain bearing (/1) or ball bearings with thread guards (/5/P FAD), see page 130.

Article code	mm	mm	mm	mm	mm	mm	kg
68/050/18/1/P	50	18	69	60 x 60	48 x 48/38 x 38	6	40
68/075/25/1/P	75	25	100	60 x 60	48 x 48/38 x 38	6	60
68/100/32/1/P	100	32	135	95 x 77	76 x 52/72 x 45	9	90
68/125/32/1/P	125	32	160	95 x 77	76 x 52/72 x 45	9	110
68/150/32/1/P	150	32	185	95 x 77	76 x 52/72 x 45	9	110
68/050/18/5/P FAD	50	18	70	60 x 60	48 x 48/38 x 38	6	40
68/075/25/5/P FAD	75	25	100	60 x 60	48 x 48/38 x 38	6	60
68/100/32/5/P FAD	100	32	135	95 x 77	76 x 52/72 x 45	9	90
68/125/32/5/P FAD	125	32	160	95 x 77	76 x 52/72 x 45	9	110
68/150/32/5/P FAD	150	32	185	95 x 77	76 x 52/72 x 45	9	110

## Institutional fixed castors

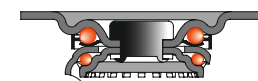

## Institutional swivel castor brackets with a load capacity of up to 110 kg

Housings made of pressed steel, zinc and chromated. Swivel head with double ball bearing and riveted kingpin. ALLSTOP total locking device on the trailing side of the housing, blocks rolling and swivel motion simultaneously.

ALLSTOP total locking device  
Code: 67 F/...P



PEVOLOP® - PEVOPLASTIC®  
PEVOTHA®  
Solid rubber wheels and castors  
Electrically conductive wheels and castors  
VULKOLLAN® - PEVOPLUR® PEVOVIM® - Soft  
Stainless steel castors  
Institutional wheels and castors  
Conveyor/guiding rollers and ball units  
Profile rollers  
Pallet rollers  
Press-on tyres

# Institutional wheels

Series 67 /1/R

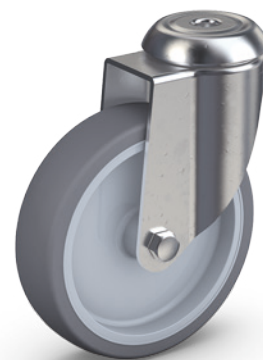

Article code	mm	mm	mm	mm	mm	kg
67/050/18/1/R	50	18	71	10	25	40
67/075/25/1/R	75	25	98	10	30	60
67/100/32/1/R	100	32	135	12	38	90
67/125/32/1/R	125	32	160	12	41	110
67/150/32/1/R	150	32	185	12	36	110
67/050/18/5/R FAD	50	18	71	10	25	40
67/075/25/5/R FAD	75	25	98	10	30	60
67/100/32/5/R FAD	100	32	135	12	38	90
67/125/32/5/R FAD	125	32	160	12	41	110
67/150/32/5/R FAD	150	32	185	12	36	110

## Institutional swivel castors with thermoplastic rubber wheels

Wheels series 85 with plain bearing (/1) or ball bearings with thread guards (/5/R FAD), see page 130.

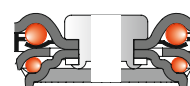

## Institutional swivel castor brackets with a load capacity of up to 110 kg

Housings made of pressed steel, zinc and chromated. Swivel head with double ball bearings and riveted kingpin. ALLSTOP total locking device on the trailing side of the housing, blocks rolling and swivel motion simultaneously.

ALLSTOP total locking device  
Code: 67 F/...R



Article code	Clamping range min mm	Clamping range max mm
69 K-R 17	16,9	17,8
69 K-R 20	19,0	21,5
69 K-R 22	21,5	24,0
69 K-R 24	24,0	27,0
69 K-R 28	27,0	30,0
69 K-R 32	31,0	35,0
69 K-V 17	16,6	18,7
69 K-V 22	21,5	24,0
69 K-V 25	24,0	27,0
69 K-V 27	27,0	30,0
69 K-V 32	32,0	35,0
69 K-V 37	36,0	40,0

## Fixing devices for institutional swivel castors with bolt hole fitting

Plastic expander for circular tubes (-R) or square tubes (-V).

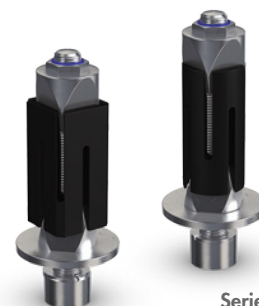

Series 69 K

PEVOLON® - PEVOELASTIC®  
PEVOTHA®  
Solid rubber wheels and castors  
Electrically conductive wheels and castors  
VULKOLLAN® - PEVOPIUR®  
PEVODVM® - Soft  
Stainless steel castors  
Institutional wheels and castors  
Conveyor/guiding rollers and ball units  
Profile rollers  
Pallet rollers  
Press-on tyres

# Institutional wheels



Series 68 PU

Series 67 PU/R

Series 67 PU

Article code	mm	mm	mm	mm	mm	mm	mm	mm	kg
67 PU/050/18/1/P	50	18	69	60 x 60	48 x 48/38 x 38	6	-	21	40
67 PU/075/24/1/P	75	24	100	60 x 60	48 x 48/38 x 38	6	-	30	60
67 PU/100/30/1/P	100	30	135	95 x 70	76 x 52/72 x 45	9	-	41	100
67 PU/125/30/1/P	125	30	160	95 x 70	76 x 52/72 x 45	9	-	39	125
67 PU/075/24/5/P	75	24	100	60 x 60	48 x 48/38 x 38	6	-	30	60
67 PU/100/30/5/P	100	30	135	95 x 70	76 x 52/72 x 45	9	-	41	100
67 PU/125/30/5/P	125	30	160	95 x 70	76 x 52/72 x 45	9	-	39	125
67 PU/050/18/1/R	50	18	69	-	-	-	10	21	40
67 PU/075/24/1/R	75	24	98	-	-	-	10	30	60
67 PU/100/30/1/R	100	30	132	-	-	-	12	41	100
67 PU/125/30/1/R	125	30	160	-	-	-	12	39	125
67 PU/075/24/5/R	75	24	98	-	-	-	10	30	60
67 PU/100/30/5/R	100	30	132	-	-	-	12	41	100
67 PU/125/30/5/R	125	30	160	-	-	-	12	39	125

Article code	mm	mm	mm	mm	mm	mm	kg
68 PU/050/18/1/P	50	18	69	60 x 60	48 x 48/38 x 38	6	40
68 PU/075/24/1/P	75	24	100	67 x 60	48 x 48/38 x 38	6	60
68 PU/100/30/1/P	100	30	135	95 x 70	76 x 52/72 x 45	9	100
68 PU/125/30/1/P	125	30	160	95 x 70	76 x 52/72 x 45	9	125
68 PU/075/24/5/P	75	24	100	67 x 60	48 x 48/38 x 38	6	60
68 PU/100/30/5/P	100	30	135	95 x 70	76 x 52/72 x 45	9	100
68 PU/125/30/5/P	125	30	160	95 x 70	76 x 52/72 x 45	9	125

## Institutional swivel castors with PEVOHAN® wheels

Wheels series 85 PU with plain bearing (/1) or ball bearings (/5), see page 130.

## Institutional fixed castors

Matching the swivel castors with top plate (/P).



## Institutional swivel castor brackets with a load capacity of up to 125 kg

Housings made of pressed steel, zinc and chromated. Swivel head with double ball bearings and riveted kingpin. With either plate or bolt hole fitting. ALLSTOP total locking device on the trailing side of the housing, blocks rolling and swivel motion simultaneously.

ALLSTOP total locking device  
Code: 67 F PU/...P

single bolt hole/total lock  
Code: 67 F PU/...R



# Institutional wheels

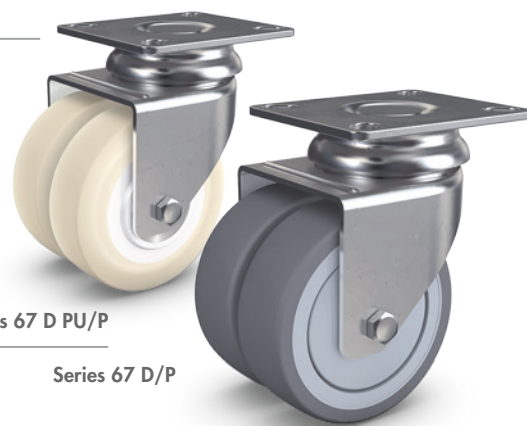

Series 67 D PU/P

Series 67 D/P

Article code	mm	mm	mm	mm	mm	mm	mm	mm	kg
67 D/050/18/1/P	50	18	72	60 x 60	48 x 48/38 x 38	6	-	30	60
67 D/075/24/1/P	75	24	103	77 x 67	61 x 51/56 x 46	8	-	30	80
67 D/050/18/5/P FAD	50	18	72	60 x 60	48 x 48/38 x 38	6	-	30	60
67 D/075/24/5/P FAD	75	24	103	77 x 67	61 x 51/56 x 46	8	-	30	80
67 D/050/18/1/R	50	18	72	-	-	-	10	30	60
67 D/075/24/1/R	75	24	103	-	-	-	10	30	80
67 D/075/24/5/R FAD	75	24	103	-	-	-	10	30	80
67 D/050/18/5/R FAD	50	18	72	-	-	-	10	30	60

## Institutional twin wheel swivel castors with thermoplastic rubber wheels

Wheels series 85 with plain bearing (/1) or ball bearings with thread guards (/5/..FAD), see page 130.

Article code	mm	mm	mm	mm	mm	mm	mm	mm	kg
67 D PU/050/18/1/P	50	18	72	60 x 60	48 x 48/38 x 38	6	-	30	60
67 D PU/075/24/5/P	75	24	103	77 x 67	61 x 51/56 x 46	8	-	30	80
67 D PU/050/18/1/R	50	18	72	-	-	-	10	30	80
67 D PU/075/24/5/R	75	24	103	-	-	-	10	30	80

## Institutional twin wheel swivel castors with PEVOTHAN® wheels

Wheels series 85 PU with plain bearing (/1) or ball bearings (/5), see page 130.

Fixing devices for institutional swivel castors with bold hole fitting(/R), see page 133.

<b>ALLSTOP total locking device</b> Code: 67 DF/...	<b>single bolt hole</b> Code: 67 D/.../...R	<b>single bolt hole/total lock</b> Code: 67 DF/.../...R
<b>ALLSTOP total locking device</b> Code: 67 DF PU/...	<b>single bolt hole</b> Code: 67 D PU/.../...R	<b>single bolt hole/total lock</b> Code: Code: 67 DF PU/.../...R

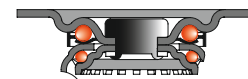

## Institutional swivel castor brackets with a load capacity of up to 80 kg

Housings made of pressed steel, zinc and chromated. Swivel head with double ball race and riveted kingpin. With either plate or bolt hole fitting. ALLSTOP total locking device on the trailing side of the housing, blocks rolling and swivel motion simultaneously.

PEVOPUR® • PEVOTHAN®  
 Solid rubber wheels and castors  
 Electrically conductive wheels and castors  
 VULKOLLAN® • PEVOPUR® PEVODIN® / -Soft  
 Stainless steel castors  
 Institutional wheels and castors  
 Conveyor/guiding rollers and ball units  
 Profile rollers  
 Pallet rollers  
 Press-on tyres

# Conveyor / guiding rollers and ball units



PEVOLON® - PEVOPLASTIC®  
PEVOTHA®

Solid rubber  
wheels and castors

Electrically conductive  
wheels and castors

VULKOLLAN® - PEVOPUR®  
PEVODYN® / -Soft

Stainless steel castors

Institutional  
wheels and castors

Conveyor / guiding  
rollers and ball units

Profile rollers

Pallet rollers

Press-on tyres

# Conveyor / guiding rollers and ball units product overview

## Conveyor / guiding rollers and ball units

We produce conveyor rollers with diameters of 30 to 85 mm and with load capacities of 10 to 490 kg. The ball units are sealed on both sides and are sprayed with PEVOLON® or PEVOTHAN®.

We produce the VULKOLLAN® guiding rollers with steel roller bodies that are very often used in materials handling with diameters of 40 to 150 mm and with load capacities from 55 to 1,030 kg.

Ball units with bright zined steel or stainless steel casing are available for a wide range of applications with a load capacity of 10 to 610 kg.

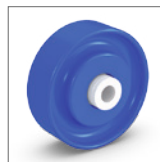

Series 600  
10 - 25 kg  
[Page 138](#)



Series 130 PA  
60 - 490 kg  
[Page 139](#)



Series 131 PA  
Series 132 PA  
70 - 270 kg  
[Page 140](#)

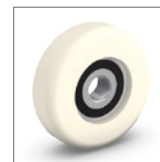

Series 130 PU  
30 - 170 kg  
[Page 141](#)

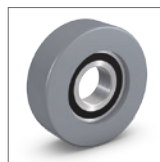

Series 130 PU HD  
Series 131 PU  
Series 133 PU  
90 - 290 kg  
[Page 142](#)

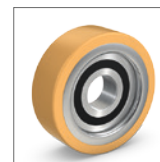

Series 173  
55 - 1.030 kg  
[Page 143](#)



Series 701  
20 - 340 kg  
[Page 144](#)



Series 702  
20 - 140 kg  
[Page 145](#)



Series 710/0  
10 - 610 kg  
[Page 146](#)

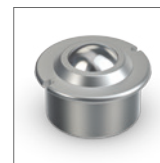

Series 710/1  
20 - 610 kg  
[Page 147](#)



# Plastic and pressed steel conveyor rollers

## Plastic rollers

Blue plastic rollers with double metal ball bearings in a high-quality polyamide cage, permanently bonded to the roller body made of shock and abrasion resistant polypropylene.

Article code	mm	mm	mm	mm	kg	
600-10/6,5	600-20/6,5*	48	16	24	6,5	10
600-10/8,0	600-20/8,5*	48	16	24	8	10

\* with white hub and stainless ball bearings

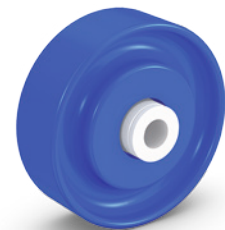

Series 600-10/ -20

## Plastic rollers with wheel flange

Blue plastic rollers, same as series 600-10, but with wheel flange.

Article code	mm	mm	mm	mm	mm	kg	
600-30/6,5	600-40/6,5*	48	16	18	24	6,5	10
600-30/8,0	600-40/8,0*	48	16	18	24	8	10

\* with white hub and stainless ball bearings

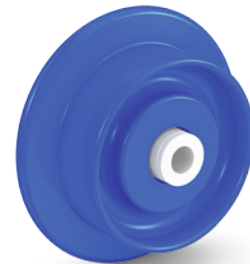

Series 600-30/ -40

## Steel rollers

Pressed steel, zinc-coated and chromate-treated, with hardened axis, with ball bearings.

Article code	mm	mm	mm	mm	kg
600-50/6,2	48	15	22	6,2	25
600-50/6,2	48	15	24	6,2	25
600-70/8,2	48	16	24	8,2	25



Series 600-50/ -70

Design same as series 600-50, however with one-sided fixing bolt.

Article code	mm	mm	mm	Bolt length/thread	kg
600-80	48	15	27	12 mm/M8	25









Series 600-80

# PE·VO·LON® conveyor rollers



Series 130 PA

 Article code	 mm	 mm	 mm	 mm	 kg
130 PA/030/011/5/8	30	11	7	8	60
130 PA/040/014,5/5/10	40	14,5	8	10	100
130 PA/040/016/5/15*	40	16	9	15	120
130 PA/040/018,5/5/10	40	18,5	8	10	140
130 PA/042/014,5/5/10	42	14,5	8	10	110
130 PA/042/014,5/5/12	42	14,5	10	12	110
130 PA/044/016/5/12	44	16	8	12	130
130 PA/050/012/5/8*	50	12	7	8	110
130 PA/050/015/5/10	50	15	9	10	140
130 PA/050/015/5/12	50	15	8	12	140
130 PA/050/020/5/12*	50	20	10	12	190
130 PA/050/018/5/12*	50	18	10	12	170
130 PA/054/022/5/12	54	22	10	12	230
130 PA/055/025/5/15 B**	55	25	9	15	270
130 PA/060/030/5/15 GF30	60	30	13	15	350
130 PA/062/020/5/12	62	20	19	12	240
130 PA/065/018,5/5/10	65	18,5	9	10	230
130 PA/065/018,5/5/12	65	18,5	10	12	230
130 PA/070/035/5/20 B**	70	35	41	20	490
130 PA/080/020/5/12	80	20	10	12	310
130 PA/080/020/5/15	80	20	10	15	310
130 PA/080/020/5/17	80	20	12	17	310
130 PA/080/025/5/25	80	25	12	25	400

GF30 = reinforced-fibreglass

as above, but roller body with wider tread

130 PA/038/028/5/12	38	28	10	12	200
130 PA/038/038/5/12	38	38	10	12	250
130 PA/042/028/5/10	42	28	8	10	220
130 PA/042/028/5/12	42	28	10	12	220
130 PA/042/038/5/12	42	38	10	12	300

\* black

\*\* with crowned tread

## PEVOLON® conveyor rollers with ball bearing

Roller body made of high-quality thermoplastic polyamide moulded around the ball bearing (/5).

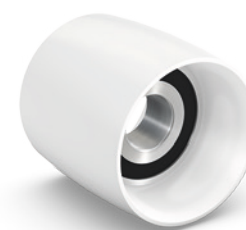

PEVOLON® • PEVOLASTIC®  
PEVOTHAN®

Solid rubber  
wheels and castors

Electrically conductive  
wheels and castors

VULKOLLAN® • PEVOPIUR®  
PEVODIN® / -Soft

Stainless steel castors

Institutional  
wheels and castors

Conveyor/guiding  
rollers and ball units

Profile rollers

Puller rollers





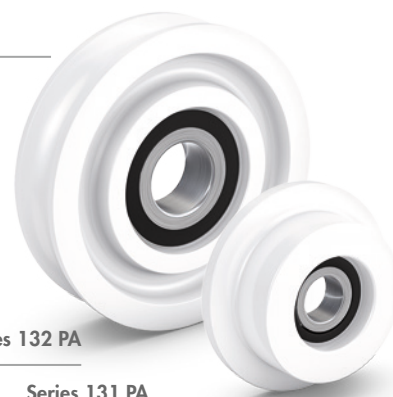



Press-on tyres

# PE·VO·LON® single flanged rollers and grooved wheels



Series 132 PA









Series 131 PA

 Article code	 mm	 mm	 mm	 mm	 mm	 mm	 kg
131 PA/035/010/050/018/5/12	50	35	18	10	8	12	70
131 PA/050/026,5/090/035/5/12*	90	50	35	26,5	10	12	270
131 PA/060/020/065/025/5/15	65	60	25	20	9	15	240
131 PA/062/019/081/026,5/5/15	82	62	26,5	19	12	15	240
131 PA/062/019/081/026,5/5/17	82	62	26,5	19	10	17	240
131 PA/062/019/081/026,5/5/17	82	62	26,5	19	11	17	240

\* with cylindrical tread

## PEVOLON® single flanged rollers with ball bearing

Roller body made of high-quality thermoplastic polyamide moulded around the ball bearing (/5).

 Article code	 mm	 mm	 mm	 mm	 mm	 mm	 kg
132 PA/065/055/018/5/17	65	55	18	4	12	17	75
132 PA/085/075/020/5/10	85	75	20	8	9	10	200
132 PA/085/075/020/5/12	85	75	20	8	10	12	200
132 PA/085/075/020/5/20	85	75	20	8	14	20	200

## PEVOLON® grooved wheels with ball bearing

Roller body made of high-quality thermoplastic polyamide moulded around the ball bearing (/5).

For more PEVOLON® single flanged rollers and grooved wheels, see page 150/151.

PEVOLON® • PEVOLOASTIC®  
PEVOTHA®

Solid rubber  
wheels and castors

Electrically conductive  
wheels and castors

VULVOLAN® • PEVOPIUR®  
PEVDIVM® / -Soft

Stainless steel castors

Institutional  
wheels and castors

Conveyor/guiding  
rollers and ball units

Profile rollers

Pallet rollers

Press-on tyres

# PE·VO·THAN® conveyor rollers

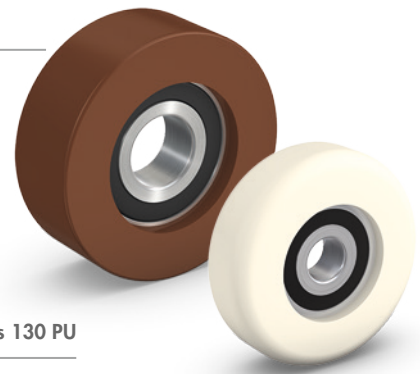

Series 130 PU

## PEVOTHAN® conveyor rollers with ball bearing

Roller body made of high-quality thermoplastic polyurethane (96° Shore A) moulded around the ball bearing (1/5).

Article code	mm	mm	mm	mm	kg
130 PU/030/011/5/8	30	11	7	8	30
130 PU/040/014,5/5/10*	40	14,5	8	10	50
130 PU/040/016/5/15**	40	16	8	15	55
130 PU/040/020/5/10	40	20	9	10	70
130 PU/042/014,5/5/10	42	14,5	8	10	55
130 PU/042/014,5/5/12	42	14,5	10	12	55
130 PU/050/015/5/10	50	15	9	10	70
130 PU/050/015/5/12	50	15	8	12	70
130 PU/050/018/5/17	50	18	11	17	80
130 PU/050/025/5/12*	50	25	10	12	100
130 PU/055/025/5/15	55	25	9	15	110
130 PU/060/018/5/12	60	18	10	12	90
130 PU/060/020/5/17	60	20	12	17	95
130 PU/062/020/5/17	62	20	14	17	110
130 PU/065/018,5/5/12	65	18,5	10	12	100
130 PU/070/025/5/20*	70	25	14	20	150
130 PU/080/020/5/12	80	20	10	12	140
130 PU/080/020/5/15	80	20	11	15	140
130 PU/080/020/5/17	80	20	12	17	140
130 PU/080/020/5/20	80	20	14	20	140
130 PU/080/025/5/25	80	25	12	25	170

as above, but roller body with wider tread

130 PU/038/028/5/12	38	28	10	12	80
130 PU/038/038/5/12	38	38	10	12	110
130 PU/042/028/5/10	42	28	8	10	90
130 PU/042/028/5/12	42	28	8	12	90
130 PU/042/038/5/12	42	38	10	12	130

\* brown

\*\* black

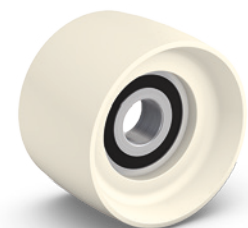

PEVOPUR® - PEVOPUR®  
PEVOTHAN®

Solid rubber  
wheels and castors

Electrically conductive  
wheels and castors

VULKOLLAN® - PEVOPUR®  
PEVODIN® - Soft

Stainless steel castors

Institutional  
wheels and castors

Conveyor/guiding  
rollers and ball units

Profile rollers

Pallet rollers

Press-on tyres

# PE·VO·THAN® / PE·VO·LASTIC® conveyor rollers

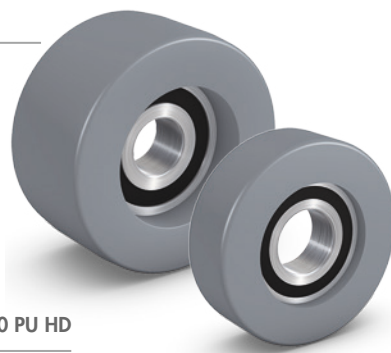

Series 130 PU HD

Article code	mm	mm	mm	mm	kg
130 PU HD/050/015/5/10	50	15	9	10	135
130 PU HD/050/018/5/15	50	18	11	15	150
130 PU HD/050/018/5/17	50	18	11	17	150
130 PU HD/050/025/5/12	50	25	10	12	170
130 PU HD/060/018/5/12	60	18	10	12	150
130 PU HD/060/020/5/17	60	20	12	17	180
130 PU HD/060/030/5/15	60	30	13	15	200
130 PU HD/070/025/5/20	70	25	14	20	270
130 PU HD/080/020/5/17	80	20	12	17	235
130 PU HD/080/025/5/20	80	25	14	20	260
130 PU HD/080/025/5/25	80	25	15	25	290

## PEVOTHAN® Heavy-duty conveyor rollers with ball bearing

Roller body made of high-quality thermoplastic polyurethane (98° Shore A / 78° Shore D) moulded around the ball bearing (/5).

## PEVOTHAN® single flanged rollers with ball bearing

Roller body made of high-quality thermoplastic polyurethane (96° Shore A) moulded around the ball bearing (/5).

Article code	mm	mm	mm	mm	mm	mm	mm	kg
131 PU/062/019/081/026/5/15	81	62	26	19	26	11	15	100
131 PU/062/019/081/026/5/17	81	62	26	19	26	12	17	100
131 PU/050/026,5/090/035/5/12	90	50	35	26,5	35	10	12	120

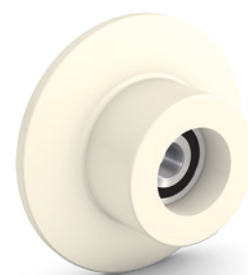

Series 131 PU

## PEVOLASTIC® conveyor rollers with ball bearing

PEVOLON® roller body with a non-detachable, mechanically bonded tread made of high-quality thermoplastic polyurethane (96° Shore A) moulded around the ball bearing (/5).

Article code	mm	mm	mm	mm	kg
133 PU/050/020/5/10	50	20	9	10	90
133 PU/080/027/5/20	80	27	14	20	190

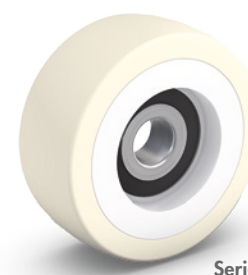

Series 133 PU

PEVOLON® - PEVOLASTIC®  
PEVOTHAN®

Solid rubber  
wheels and castors

Electrically conductive  
wheels and castors

VULKOLLAN® - PEVOPIUR®  
PEVODIN® - Soft

Stainless steel castors

Institutional  
wheels and castors

Conveyor/guiding  
rollers and ball units

Profile rollers

Puller rollers

Press-on tyres

# VULKOLLAN® guiding rollers

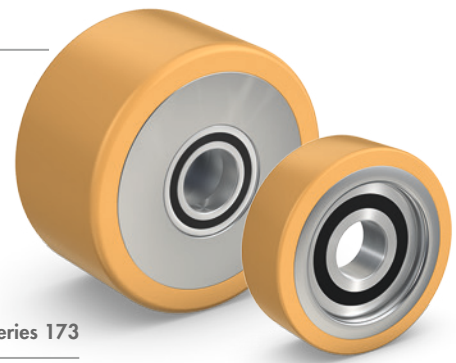

Series 173

Article code	mm	mm	mm	mm	kg
173/040/015/5/10	40	15	8	10	55
173/040/020/5/10	40	20	8	10	70
173/040/025/5/10	40	25	8	10	90
173/050/015/5/10	50	15	9	10	70
173/050/018/5/17	50	18	10	17	80
173/050/020/5/12	50	20	10	12	90
173/055/020/5/12	55	20	10	12	100
173/055/020/5/15	55	20	10	15	100
173/060/020/5/17	60	20	12	17	110
173/060/020/5/20	60	20	12	20	110
173/070/020/5/17	70	20	12	17	125
173/070/020/5/20	70	20	12	20	120
173/070/025/5/20	70	25	14	20	160
173/070/025/5/25	70	25	15	25	160
173/080/025/5/20	80	25	15	20	180
173/080/025/5/25	80	25	15	25	180
173/090/025/5/25	90	25	15	25	200
173/100/025/5/25	100	25	15	25	220
173/120/025/5/20	120	25	15	20	270
173/120/025/5/25	120	25	15	25	270
173/120/030/5/30	120	30	13	30	320
173/125/030/5/20	125	30	30	20	335
173/125/030/5/25	125	30	35	25	335
173/150/050/5/35	150	50	42	35	680
173/150/080/5/35	150	80	80	35	1.030

## VULKOLLAN® guiding rollers with ball bearing

Roller body made of steel with force-fitted roller bearing (1/5) and direct bonded VULKOLLAN® tread (93° Shore A).

- PEVOPLASTIC® PEVOHAN®
- Solid rubber wheels and castors
- Electrically conductive wheels and castors
- VULKOLLAN® • PEVOPLUR® PEVOVIM® - Soft
- Stainless steel castors
- Institutional wheels and castors
- Conveyor/guiding rollers and ball units
- Profile rollers
- Pallet rollers
- Press-on tyres



# Ball units



Series 701

## Ball units with steel housing

Housing bright zinc plated steel or stainless steel. Steel, nylon (N) or stainless steel (R) load ball.

 Article code	Ball Ø mm	D mm	D1 mm	H mm	h mm	a mm	b mm	Hole Ø mm	Bolt hole spacing mm	 kg
701-20/0-F2	20	29	61	22	10	3	7	5	45	25
701-25/0-F2	25	38	73	30	14	3	8	5	56	55
701-32/0-F2	32	46	73	36	16	4	8	5	59	125
701-40/0-F2	40	56	89	46	22	6	13	7	70	140
701-50/0-F3	50	75	121	59	29	6	14	8	92	340

### with nylon ball, zinc housing

701 N-20/0-F2	20	29	61	22	10	3	7	5	45	20
701 N-25/0-F2	25	38	73	30	14	3	8	5	56	25

### stainless steel housing and ball

701 R-20/0-F2	20	29	61	22	10	3	7	5	45	25
701 R-25/0-F2	25	38	73	30	14	3	8	5	56	55
701 R-32/0-F2	32	46	73	36	16	4	8	5	59	125
701 R-40/0-F2	40	56	89	46	22	6	13	7	70	140
701 R-50/0-F3	50	75	121	59	29	6	14	8	92	340

F2 = 2-Fixing holes, F3 = 3-Fixing holes

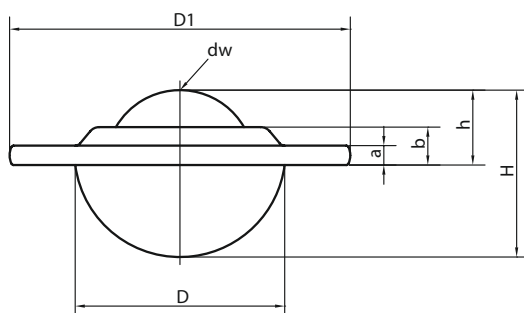

Design Series 701



# Ball units



Series 702

## Ball units with bolt fixing

Housing bright zinc plated or stainless steel. Steel, nylon (N) or stainless steel (R) load ball.

 Article code	Ball Ø mm	D mm	H mm	h mm	a mm	b mm	Fixing bolt mm	 kg
702-19/1	19	32,1	65,2	30,2	4,7	25,4	M8 x 35	20
702-25/1	25	39,7	82,7	39,7	6,3	33,4	M8 x 43	55
702-40/1	40	55,5	96,8	54,8	11,9	42,9	M10 x 42	140

### with nylon ball, zinc plated housing

702 N-19/1	19	32,1	65,2	30,2	4,7	25,4	M8 x 35	20
702 N-25/1	25	39,7	82,7	39,7	6,3	33,4	M8 x 43	25

### stainless steel housing and ball

702 R-19/1	19	32,1	75,2	30,2	4,7	25,4	M8 x 45	20
702 R-25/1	25	39,7	72,7	39,7	6,3	33,4	M8 x 43	55
702 R-40/1	40	55,5	86,8	54,8	11,9	42,9	M10 x 32	140

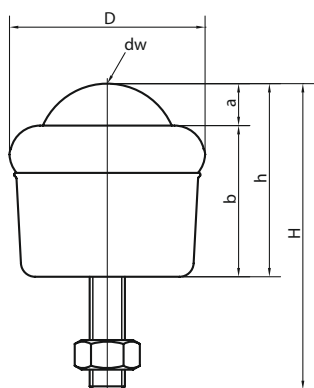

Design Series 702

PEVOLON® - PEVOPLASTIC®  
PEVOTHA®

Solid rubber  
wheels and castors

Electrically conductive  
wheels and castors

VULKOLAN® - PEVOPLUR®  
PEVODYN® / -Soft

Stainless steel castors

Institutional  
wheels and castors

Conveyor/guiding  
rollers and ball units

Profile rollers

Puller rollers

Press-on tyres



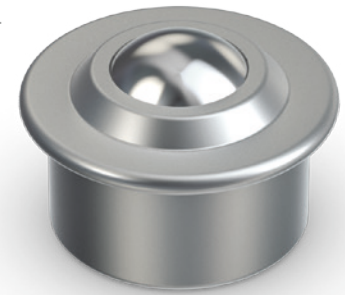

# EURO ball units



Series 710/0

## EURO ball units with steel housing

Housing with separate hardened bearing cup, bright zinc plated or stainless steel.  
Steel support ball. Steel, nylon or stainless steel load balls.

 Article code	Ball Ø mm	D mm	D1 mm	H mm	h mm	a mm	b mm	 kg
710-15/0	15	24	31	21,0	9,5	2,8	6,3	60
710-22/0	22	36	45	30,0	9,8	2,8	5,5	160
710-30/0	30	45	55	37,0	13,8	4,0	8,3	300
710-45/0	45	62	75	53,5	19,0	4,0	10,0	610

### with nylon ball, zined housing

710 N-15/0	15	24	31	21,0	9,5	2,8	6,3	10
710 N-22/0	22	36	45	30,0	9,8	2,8	5,5	20
710 N-30/0	30	45	55	37,0	13,8	4,0	8,3	25

### with stainless steel ball, zined housing

710 S-15/0	15	24	31	21,0	9,5	2,8	6,3	60
710 S-22/0	22	36	45	30,0	9,8	2,8	5,5	160
710 S-30/0	30	45	55	37,0	13,8	4,0	8,3	300
710 S-45/0	45	62	75	53,5	19,0	4,0	10,0	610

### stainless steel housing and ball

710 R-15/0	15	24	31	21,0	9,5	2,8	6,3	38
710 R-22/0	22	36	45	30,0	9,8	2,8	5,5	100
710 R-30/0	30	45	55	37,0	13,8	4,0	8,3	200
710 R-45/0	45	62	75	53,5	19,0	4,0	10,0	250

PEVOLON® - PEVOELASTIC®  
PEVOHAN®

Solid rubber  
wheels and castors

Electrically conductive  
wheels and castors

VULKOLAN® - PEVOPIUR®  
PEVOVIN® - Soft

Stainless steel castors

Institutional  
wheels and castors

Conveyor/guiding  
rollers and ball units

Profile rollers

Pallet rollers

Press-on tyres

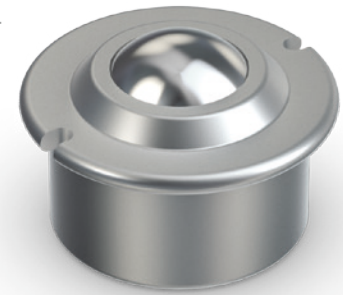

# EURO ball units



Series 710/1

## EURO ball units with steel housing and two slotted holes.

Housing with separate hardened bearing cup, bright zinc plated or stainless steel.  
Steel support ball. Steel, nylon or stainless steel load balls.

 Article code	Ball Ø mm	D mm	D1 mm	H mm	h mm	a mm	b mm	Hole Ø mm	Bolt hole spacing mm	 kg
710-15/1	15	24	31	21,0	9,5	2,8	6,3	3,5	29	60
710-22/1	22	36	45	30,0	9,8	2,8	5,5	3,5	42	160
710-30/1	30	45	55	37,0	13,8	4,0	8,3	3,5	51	300
710-45/1	45	62	75	53,5	19,0	4,0	10,0	4,3	69	610

### with nylon ball, zinc housing

710 N-22/1	22	36	45	30,0	9,8	2,8	5,5	3,5	42	20
710 N-30/1	30	45	55	37,0	13,8	4,0	8,3	3,5	51	25

### with stainless steel ball, zinc housing

710 S-22/1	22	36	45	30,0	9,8	2,8	5,5	3,5	42	160
710 S-30/1	30	45	55	37,0	13,8	4,0	8,3	3,5	51	300

### stainless steel housing and ball

710 R-15/1	15	24	31	21,0	9,5	2,8	6,3	3,5	29	38
710 R-22/1	22	36	45	30,0	9,8	2,8	5,5	3,5	42	100

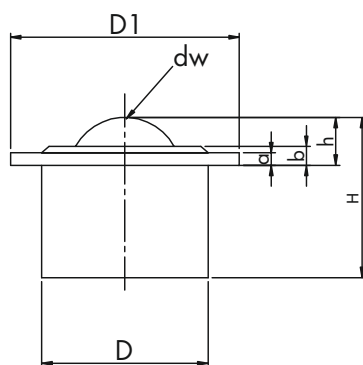

Design Series 710

# Profile rollers



Press-on tyres

Pallet rollers

Profile rollers

Conveyor/guiding rollers and ball units

Institutional wheels and castors

Stainless steel castors

VULKOLLAN® • PEVOPIK® PEVOVIM® / -Soft

Electrically conductive wheels and castors

Solid rubber wheels and castors

PEVOLON® • PEVOELASTIC® PEVOTHAN®

# Profile rollers product overview

## Profile rollers

### FLANGED/GROOVED WHEELS

We produce a variety of flanged and grooved wheels with different dimensions, bearing types and load capacities using materials such as PEVOLON®, steel and grey cast iron.

Due to our efficient plastics and mechanical production with our own mould making, toolmaking and fixture construction, we are able to produce high-quality and cost-efficient products according to your specifications and drawings.



Series E/1  
Series F/1  
20 - 500 kg  
[Page 150](#)



Series D/1  
35 - 380 kg  
[Page 151](#)



Series 107  
2.000 - 7.250 kg  
[Page 152](#)



Series 106  
500 - 1.500 kg  
[Page 153](#)

**PE·VO·LON®**

# grooved and flanged wheels













Series F/5

Series E/1











## PEVOLON® grooved wheels

High-quality thermoplastic polyamide. With maintenance-free plain bearing (/1) or ball bearings (/5).

 Article code	 mm	 mm	 mm	 mm	 mm	 mm	 mm	 mm	 kg
E 050/010/1/15	50	40	10	11	25	4	15	30	
E 053/023/1/10	53	25	23	25	25	15	10	50	
E 060/030/1/12	60	38	30	18	30	20	12	90	
E 060/020/1/08	60	53	20	27	20	9	08	50	
E 060/030/1/10	60	38	30	32	20	20	10	90	
E 073/013/1/10	73	65	13	17	20	8	10	55	
E 076/016/1/11	76	67	16	17	28	10	11	90	
E 080/022/1/12	80	62	22	25	30	12	12	140	
E 100/012/1/10	100	84	12	17	30	3,5	10	85	
E 100/025/1/15	100	76	25	28	32	17	15	210	
E 100/042/1/20	100	68	42	27	50	28	20	270	
E 120/027/1/15	120	88	27	33	40	18	15	300	
E 120/022/1/20	120	88	22	27	50	12	20	240	
E 126/034/1/30	126	102	34	42	70	14	30	500	
E 130/018/1/15	130	110	18	30	30	6	15	150	
E 150/033/1/20	150	110	33	42	44	25	20	410	
E 150/033/1/25	150	135	33	42	60	15	25	450	
E 076/016/5/08	76	67	16	16	28	10	08	90	

## PEVOLON® double-flanged wheels

High-quality thermoplastic polyamide. With maintenance-free plain bearing (/1) or ball bearings (/5).

 Article code	 mm	 mm	 mm	 mm	 mm	 mm	 mm	 mm	 kg
F 045/029/1/08	45	28	29	29	–	24 / 20	9	08	45
F 050/010/1/10	50	40	10	11	18	6	5	10	20
F 050/016/1/12	50	40	16	16	–	14 / 10	8	12	35
F 060/019/5/10	60	40	19	22	–	12 / 10	10	10	40

PEVOLON® PEVOPLASTIC® PEVOTHA®  
 Solid rubber wheels and castors  
 Electrically conductive wheels and castors  
 VULKOLLAN® PEVOPLUR® PEVDIVM® -Soft  
 Stainless steel castors  
 Institutional wheels and castors  
 Conveyor/guiding rollers and ball units  
 Profile rollers  
 Pallet rollers  
 Press-on tyres

# PE·VO·LON®

## single-flanged wheels



Series D/1

Article code	mm	mm	mm	mm	mm	mm	mm	kg
D 030/015/050/020/1/10	50	30	20	15	20	–	10	35
D 035/025/050/032/1/16	50	35	32	25	34	30	16	80
D 035/028/050/037,5/1/15	50	35	37,5	28	38,5	30	15	80
D 035/028/065/037,5/1/15	65	35	37,5	28	38,5	30	15	80
D 040/012/055/018/1/15	55	40	18	12	18	–	15	40
D 050/020/070/028/1/16	70	50	28	20	30	22	16	100
D 050/024/065/032/1/15	65	50	32	24	29	–	15	100
D 050/020/065/025/1/10	65	50	25	20	25	–	10	90
D 062/019/080/026/1/16	80	62	26	19	29	35	16	100
D 062/019/075/026/1/16	75	62	26	19	29	35	16	100
D 087/025/108/033/1/16	108	87	33	25	33	–	16	200
D 100/032/120/045/1/20	120	100	45	32	40	50	20	280
D 120/030/150/042/1/38	150	120	45	30	45	80	38	380

### PEVOLON® single-flanged wheels with plain bearing

High-quality thermoplastic polyamide. With maintenance-free plain bearing (/1).









For more PEVOLON® grooved and flanged wheels with ball bearing, see page 140.

# Steel single-flanged wheels











Series 107/5

Series 107/2

							
Article code	mm	mm	mm	mm	mm	mm	kg
107 A/200/060/225/075/2/30 H7	225	200	75	60	75	30	4.500
107 A/200/060/225/075/2/40 H7	225	200	75	60	75	40	4.500
107 A/200/060/225/075/2/45 H7	225	200	75	60	75	45	4.500
107 A/200/060/225/075/2/50 H7	225	200	75	60	75	50	4.500
107 A/200/060/225/075/2/60 H7	225	200	75	60	75	60	4.500
107 A/250/060/275/075/2/40 H7	275	250	75	60	75	40	5.600
107 A/250/060/275/075/2/50 H7	275	250	75	60	75	50	5.600
107 A/250/060/275/075/2/60 H7	275	250	75	60	75	60	5.600
107 A/300/065/330/080/2/50 H7	330	300	80	65	80	50	7.250
107 A/300/065/330/080/2/60 H7	330	300	80	65	80	60	7.250

## Single-flanged steel wheels with bore

Single-flanged wheels turned from C45 steel (solid material) with cylindrical tread. Wheel centre with bore H7 and keyway according to DIN 6885.

							
Article code	mm	mm	mm	mm	mm	mm	kg
107/160/060/180/075/5/35	180	160	75	60	75	35	2.000
107/200/060/225/075/5/40	225	200	75	60	75	40	2.800
107/250/060/275/075/5/50	275	250	75	60	75	50	4.600

## Single-flanged steel wheels with ball bearings

Single-flanged wheels turned from C45 steel (solid material) with cylindrical tread. Wheel centre with ball bearings (/5).

Technical information: The indicated load capacities are obtained from the permissible pressure between wheel and rail with maximum possible rail head width and  $v = 40 \text{ m/min}$  (= 2,4 km/h).

# Cast-iron single-flanged wheels



Series 106/5

Series 106/1

Article code	mm	mm	mm	mm	mm	mm	mm	kg
106/075/030/095/040/1/20	95	75	40	30	47	56	20	500
106/100/036/125/046/1/20	125	100	46	36	54	56	20	750
106/150/036/175/046/1/20	175	150	46	36	52	63	20	850
106/180/033/210/047/1/30	210	180	47	33	52	66	30	1.000
106/200/038/230/056/1/30	230	200	56	38	60	60	30	1.250
106/250/045/290/065/1/40	290	250	65	45	70	92	40	1.500

106/075/030/095/040/5/20	95	75	40	30	47	55	20	500
106/100/036/125/046/5/20	125	100	46	36	54	55	20	750
106/150/036/175/046/5/20	175	150	46	36	52	62	20	850
106/180/033/210/047/5/20	210	180	47	33	52	66	20	1.000
106/200/038/230/056/5/25	230	200	56	38	60	92	25	1.250
106/250/045/290/065/5/30	290	250	65	45	70	92	30	1.500

## Grey cast-iron single-flanged wheels

Single-flanged wheels with plain bearing (/1) or ball bearings (/5). Wheel flange and conical tread properly machined.

PEVOLON® • PEVOPLASTIC®  
PEVOTHA®

Solid rubber  
wheels and castors

Electrically conductive  
wheels and castors

VULKOLLAN® • PEVOPLUR®  
PEVODYN® - Soft

Stainless steel castors

Institutional  
wheels and castors

Conveyor/guiding  
rollers and ball units

Profile rollers

Pallet rollers

Press-on tyres



# VULKOLLAN®/PE·VO·PUR®/PE·VO·LON® PE·VO·DYN®-Soft **pallet rollers**



PEVOLON® • PEVOPLASTIC®  
PEVOTHA®

Solid rubber  
wheels and castors

Electrically conductive  
wheels and castors

VULKOLLAN® • PEVOPUR®  
PEVOVYN® / -Soft

Stainless steel castors

Institutional  
wheels and castors

Conveyor/guiding  
rollers and ball units

Profile rollers

Pallet rollers

Press-on tyres

# VULKOLLAN®/PE·VO·PUR®/PE·VO·LON® PE·VO·DYN®-Soft pallet rollers product overview

## Pallet rollers

We offer one of the largest ranges of pallet rollers on the European market. For almost all standard electrically operated industrial trucks and all hand-operated pallet trucks, we produce VULKOLLAN®, PEVOPUR®, PEVOLON® and PEVODYN®-Soft pallet rollers.

A multitude of high quality gaskets made of zinc-plated steel or PEVOLON® ensure additional protection of the ball units against dust and splash water and guarantee a long service life.



Series CK  
600 - 1.300 kg  
[Page 156](#)



Series CKV  
600 - 1.000 kg  
[Page 157](#)



Series 174  
250 - 900 kg  
[Page 158 - 159](#)



Series 174 VKS  
350 - 850 kg  
[Page 160](#)



Series 174 PUR  
350 - 850 kg  
[Page 161](#)



Series 174 PURVKS  
450 - 850 kg  
[Page 162](#)



Series 174 PD-S  
360 - 680 kg  
[Page 163](#)

# PE·VO·LON® pallet rollers



Series CK

Article code	mm	mm	mm	mm	kg
CK 70/066/070/20	70	66	70	20	600
CK 80/057/061/20	80	57	61	20	600
CK 80/057/061/25	80	57	61	25	600
CK 80/070/074/20	80	70	74	20	700
CK 80/070/074/25	80	70	74	25	700
CK 82/066/071/20	82	66	71	20	700
CK 82/070/074/20	82	70	74	20	700
CK 82/072/078/20	82	72	78	20	750
CK 82/091/096/20*	82	91	96	20	900
CK 82/098/102/20	82	98	102	20	1.000
CK 82/098/102/25	82	98	102	25	1.000
CK 82/098/105/20	82	98	105	20	1.000
CK 82/118/122/25	82	118	122	25	1.200
CK 85/046/050/20	85	46	50	20	500
CK 85/059,5/061,5/17*	85	59,5	61,5	17	600
CK 85/061/065/25	85	61	65	25	650
CK 85/063/067/20	85	63	67	20	700
CK 85/066/070/20*	85	66	70	20	750
CK 85/075/078/17*	85	75	78	17	800
CK 85/078/082/25	85	78	82	25	850
CK 85/085/089/20	85	85	89	20	900
CK 85/090/094/20	85	90	94	20	950
CK 85/095/099/20	85	95	99	20	1.000
CK 85/100/100/17	85	100	100	17	1.100
CK 85/100/102/17*	85	100	102	17	1.100
CK 85/100/104/20	85	100	104	20	1.100
CK 85/104/110/20	85	104	110	20	1.100
CK 85/110/114/25	85	110	114	25	1.200
CK 85/120/124/20	85	120	124	20	1.300
CK 85/120/124/25	85	120	124	25	1.300

\* with labyrinth sealing

## PEVOLON® pallet rollers with ball bearings

Roller body made of high-quality thermoplastic polyamide with ball bearings.

PEVOLON® - PEVOPLASTIC®  
PEVOTHA®

Solid rubber  
wheels and castors

Electrically conductive  
wheels and castors

VULKOLAN® - PEVOPUR®  
PEVODYN® / -Soft

Stainless steel castors

Institutional  
wheels and castors

Conveyor/guiding  
rollers and ball units

Profile rollers





Pallet rollers

Press-on tyres

# PE·VO·LON® pallet rollers



Series CKV

Article code	 mm	 mm	 mm	 mm	 kg
CK V 80/063/067/20	80	63	67	20	600
CK V 80/065/070/20	80	65	70	20	600
CK V 80/070/075/20	80	70	75	20	600
CK V 82/065/070/20	82	65	70	20	700
CK V 82/069/074/20	82	69	74	20	700
CK V 82/070/075/20	82	70	75	20	700
CK V 82/072/078/17	82	72	78	17	800
CK V 82/072/078/20	82	72	78	20	750
CK V 82/097/102/20	82	97	102	20	1.000
CK V 82/100/105/20	82	100	105	20	1.000
CK V 85/069/074/20	85	69	74	20	750
CK V 85/073/078/17	85	73	78	17	800
CK V 85/075/080/20	85	75	80	20	800
CK V 85/090/095/20	85	90	95	20	900
CK V 85/097/102/17	85	97	102	17	1.000

## PEVOLON® pallet rollers with sealed ball bearings

Roller body made of high-quality thermoplastic polyamide with ball bearings. Plastic sealing and V-ring gasket for protection of the ball bearings against splash water and foreign matter.

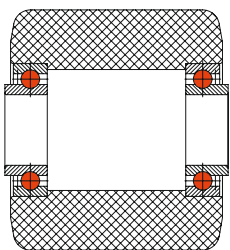

ZZV-ball bearing

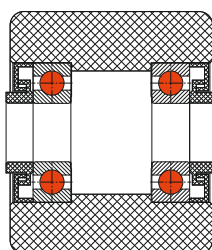

Labyrinth sealing

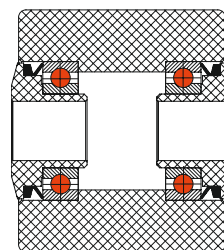

V-ring sealing gasket

PEVOLON® - PEVOLOASTIC®  
PEVOHAN®

Solid rubber  
wheels and castors

Electrically conductive  
wheels and castors

VULKOLLAN® - PEVOPIUR®  
PEVOVIM® - Soft

Stainless steel castors

Institutional  
wheels and castors

Conveyor/guiding  
rollers and ball units

Profile rollers

Pallet rollers

Press-on tyres

# VULKOLLAN® pallet rollers

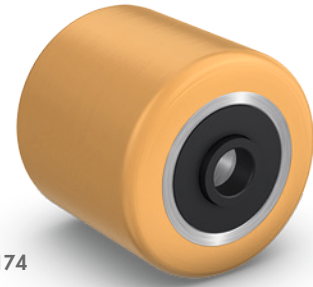

Series 174

Article code	mm	mm	mm	mm	kg
174/80/054/060/20	80	54	60	20	400
174/80/057/059/20	80	57	59	20	400
174/80/057/061/20	80	57	61	20	400
174/80/057/061/25	80	57	61	25	400
174/80/070/074/20	80	70	74	20	450
174/80/100/104/20	80	100	104	20	650
174/82/034/034,6/17	82	34	34,6	17	250
174/82/050/052/20	82	50	52	20	400
174/82/053/055/17*	82	53	55	17	400
174/82/065/063/20	82	65	63	20	450
174/82/065/067/20	82	65	67	20	450
174/82/069/062/20	82	69	62	20	500
174/82/070/066/20	82	70	66	20	500
174/82/070/072/20	82	70	72	20	500
174/82/070/074/20	82	70	74	20	500
174/82/072/078/20	82	72	78	20	500
174/82/072/078/20*	82	72	78	20	500
174/82/082/086/20	82	82	86	20	600
174/82/089/082/20	82	89	82	20	650
174/82/098/105/20	82	98	105	20	700
174/82/098/105/20*	82	98	105	20	700
174/82/100/095/20	82	100	95	20	700
174/82/100/104/20	82	100	104	20	700
174/85/043/043/20	85	43	43	20	300
174/85/046/048/25	85	46	48	25	350
174/85/046/050/20	85	46	50	20	350
174/85/050/055/25*	85	50	55	25	400
174/85/055/060/20*	85	55	60	20	420
174/85/059,5/061,5/17*	85	59,5	61,5	17	450

## VULKOLLAN® pallet rollers with ball bearings

Roller body made of steel tube with ball bearings. Direct bonded VULKOLLAN® tread (93° Shore A).

PEVOLON® - PEVOLASTIC®  
PEVOTHA®

Solid rubber  
wheels and castors

Electrically conductive  
wheels and castors

VULKOLLAN® - PEVOPUR®  
PEVODIN® - Soft

Stainless steel castors

Institutional  
wheels and castors

Conveyor/guiding  
rollers and ball units

Profile rollers





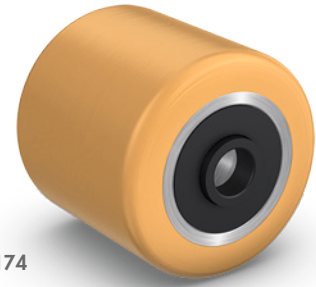

Pallet rollers

Press-on tyres

# VULKOLLAN® pallet rollers



Series 174

 Article code	 mm	 mm	 mm	 mm	 kg
174/85/061/065/20	85	61	65	20	450
174/85/070/063/17	85	70	63	17	500
174/85/075/077/20	85	75	77	20	550
174/85/075/080/20*	85	75	80	20	580
174/85/078/078/20	85	78	78	20	600
174/85/078/080/20	85	78	80	20	600
174/85/080/082/17*	85	80	82	17	600
174/85/080/082/25	85	80	82	25	600
174/85/080/084/20*	85	80	84	20	600
174/85/080/085/20*	85	80	85	20	600
174/85/086,5/088,5/17*	85	86,5	88,5	17	650
174/85/090/092/25	85	90	92	25	700
174/85/095/100/20*	85	95	100	20	750
174/85/100/102/17*	85	100	102	17	800
174/85/100/102/25*	85	100	102	25	800
174/85/100/104/25	85	100	104	25	800
174/85/105/110/25*	85	105	110	25	800
174/85/120/124/20	85	120	124	20	900

\* with labyrinth sealing

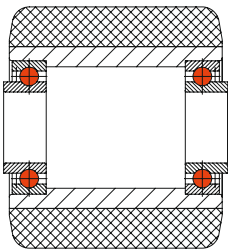

ZZV-ball bearing

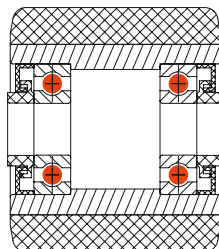

Labyrinth sealing

PEVOPUR® - PEVOPLASTIC®  
PEVOHYAN®

Solid rubber  
wheels and castors

Electrically conductive  
wheels and castors

VULKOLLAN® - PEVOPUR®  
PEVOHYAN® - Soft

Stainless steel castors

Institutional  
wheels and castors

Conveyor/guiding  
rollers and ball units

Profile rollers

Pallet rollers

Press-on tyres

# VULKOLLAN® pallet rollers

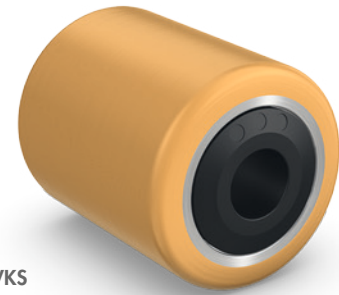

Series 174 VKS

## VULKOLLAN® pallet rollers with sealed ball bearings

Roller body made of steel tube with ball bearings. Direct bonded VULKOLLAN® tread (93° Shore A). Plastic sealing and V-ring gasket for protection of the ball bearings against splash water and foreign matter.

Article code	mm	mm	mm	mm	kg
174 VKS/80/074/076/13	80	74	76	13	500
174 VKS/80/095/100/20	80	95	100	20	700
174 VKS/82/050/055/20	82	50	55	20	350
174 VKS/82/065/070/20	82	65	70	20	450
174 VKS/82/069/074/20	82	69	74	20	500
174 VKS/82/070/075/20	82	70	75	20	500
174 VKS/82/072/077/17	82	72	77	17	500
174 VKS/82/075/080/20	82	75	80	20	550
174 VKS/85/060/065/12	85	60	65	12	450
174 VKS/85/060/065/20	85	60	65	20	450
174 VKS/85/060/065/25	85	60	65	25	450
174 VKS/85/070/075/20	85	70	75	20	500
174 VKS/85/070/075/25	85	70	75	25	500
174 VKS/85/073/078/20	85	73	78	20	550
174 VKS/85/075/080/12	85	75	80	12	580
174 VKS/85/075/080/20	85	75	80	20	550
174 VKS/85/075/080/25	85	75	80	25	550
174 VKS/85/078/082/12	85	78	82	12	600
174 VKS/85/080/082/17	85	80	82	17	600
174 VKS/85/080/085/12	85	80	85	12	600
174 VKS/85/080/085/20	85	80	85	20	600
174 VKS/85/080/085/25	85	80	85	25	490
174 VKS/85/085/089,7/25	85	85	89,7	25	660
174 VKS/85/085/090/12	85	85	90	12	650
174 VKS/85/085/090/20	85	85	90	20	650
174 VKS/85/085/090/25	85	85	90	25	650
174 VKS/85/090/095/20	85	90	95	20	700
174 VKS/85/090/095/25	85	90	95	25	700
174 VKS/85/095/100/17	85	95	100	17	750
174 VKS/85/095/100/20	85	95	100	20	750
174 VKS/85/095/100/25	85	95	100	25	750
174 VKS/85/100/105/20	85	100	105	20	800
174 VKS/85/100/105/25	85	100	105	25	800
174 VKS/85/105/110/13	85	105	110	13	800
174 VKS/85/105/110/20	85	105	110	20	800
174 VKS/85/105/110/25	85	105	110	25	800
174 VKS/85/110/115/25	85	110	115	25	850

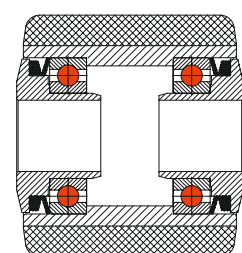

V-ring sealing gasket

PEVOLLON® - PEVOPLASTIC®  
PEVOTHA®  
Solid rubber wheels and castors  
Electrically conductive wheels and castors  
VULKOLLAN® - PEVOPLUR® PEVOVIV® - Soft  
Stainless steel castors  
Institutional wheels and castors  
Conveyor/guiding rollers and ball units  
Profile rollers  
Pallet rollers  
Press-on tyres

# PE·VO·PUR® pallet rollers

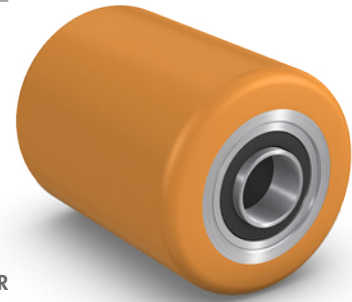

Series 174 PUR

## PEVOPUR® pallet rollers with ball bearings

Roller body made of steel tube with ball bearings. Direct bonded PEVOPUR® tread (93° Shore A).

Article code	mm	mm	mm	mm	kg
174 PUR/80/054/060/20	80	54	60	20	400
174 PUR/80/057/061/20	80	57	61	20	400
174 PUR/80/057/061/25	80	57	61	25	400
174 PUR/80/061/065/20	80	61	65	20	400
174 PUR/80/070/072/20	80	70	72	20	450
174 PUR/82/062/064/20	82	62	64	20	450
174 PUR/82/066/071/20	82	66	71	20	450
174 PUR/82/068/074/20	82	68	74	20	500
174 PUR/82/070/066/20	82	70	66	20	500
174 PUR/82/070/070/20	82	70	70	20	500
174 PUR/82/070/072/20	82	70	72	20	500
174 PUR/82/070/074/20	82	70	74	20	500
174 PUR/82/072/078/20	82	72	78	20	550
174 PUR/82/078/082/20	82	78	82	20	600
174 PUR/82/090/085/20	82	90	85	20	650
174 PUR/82/091/096/20*	82	91	96	20	650
174 PUR/82/096/098/20	82	96	98	20	700
174 PUR/82/100/096/20	82	100	96	20	700
174 PUR/82/100/104/20	82	100	104	20	700
174 PUR/85/046/050/20	85	46	50	20	350
174 PUR/85/060/065/20*	85	60	65	20	450
174 PUR/85/070/070/17	85	70	70	17	500
174 PUR/85/070/070/20	85	70	70	20	500
174 PUR/85/075/075/20	85	75	75	20	550
174 PUR/85/078/078/20	85	78	78	20	600
174 PUR/85/080/082/17*	85	80	82	17	600
174 PUR/85/080/082/25	85	80	82	25	600
174 PUR/85/080/085/20*	85	80	85	20	600
174 PUR/85/082/087,5/25	85	82	88	25	600
174 PUR/85/086,5/088,5/17*	85	87	88,5	17	650
174 PUR/85/090/090/20	85	90	90	20	700
174 PUR/85/090/094/20	85	90	94	20	700
174 PUR/85/095/095/20	85	95	95	20	750
174 PUR/85/100/102/17*	85	100	102	17	800
174 PUR/85/100/102/20	85	100	102	20	800
174 PUR/85/105/110/25*	85	105	110	25	800
174 PUR/85/110/114/25	85	110	114	25	850

\* with labyrinth sealing

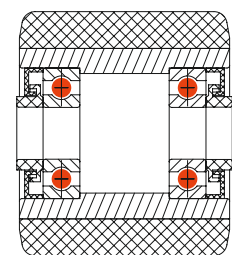

Labyrinth sealing

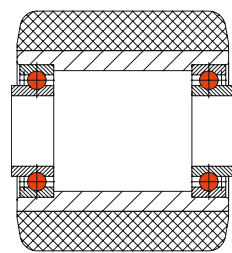

ZZV-ball bearing

PEVOPUR® - PEVOPUR®  
PEVOTHA®

Solid rubber  
wheels and castors

Electrically conductive  
wheels and castors

VULKOLLAN® - PEVOPUR®  
PEVODIN® - Soft

Stainless steel castors

Institutional  
wheels and castors

Conveyor/guiding  
rollers and ball units

Profile rollers

Pallet rollers

Press-on tyres





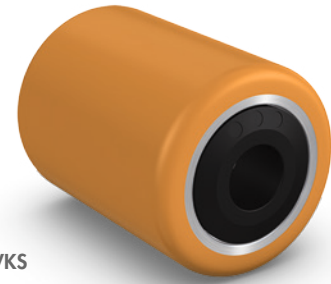

# PE·VO·PUR® pallet rollers



Series 174 PUR VKS

## PEVOPUR® pallet rollers with sealed ball bearings

Roller body made of steel tube with ball bearings. Direct bonded PEVOPUR® tread (93° Shore A). Plastic sealing and V-ring gasket for protection of the ball bearings against splash water and foreign matter.

Article code	 mm	 mm	 mm	 mm	 kg
174 PUR VKS/80/070/074,7/20	80	70	74,7	20	450
174 PUR VKS/82/065/070/20	82	65	70	20	450
174 PUR VKS/82/069/074/20	82	69	74	20	500
174 PUR VKS/82/098/102/20	82	98	102	20	700
174 PUR VKS/85/060/065/12	85	60	65	12	450
174 PUR VKS/85/060/065/20	85	60	65	20	450
174 PUR VKS/85/060/065/25	85	60	65	25	450
174 PUR VKS/85/065/070/17	85	65	70	17	500
174 PUR VKS/85/065/070,5/20	85	65	70,5	20	500
174 PUR VKS/85/070/070/20	85	70	70	20	500
174 PUR VKS/85/070/075/20	85	70	75	20	500
174 PUR VKS/85/073/078/20	85	73	78	20	550
174 PUR VKS/85/075/080/20	85	75	80	20	550
174 PUR VKS/85/075/080/25	85	75	80	25	550
174 PUR VKS/85/080/085/12	85	80	85	12	600
174 PUR VKS/85/080/085/20	85	80	85	20	600
174 PUR VKS/85/080/085/25	85	80	85	25	600
174 PUR VKS/85/085/090/12	85	85	90	12	650
174 PUR VKS/85/090/090/20	85	90	90	20	700
174 PUR KS/85/095/097/25	85	95	97	25	740
174 PUR VKS/85/095/100/20	85	95	100	20	750
174 PUR VKS/85/100/102/25	85	100	102	25	800
174 PUR VKS/85/100/105/20	85	100	105	20	800
174 PUR VKS/85/100/105/25	85	100	105	25	800
174 PUR VKS/85/105/110/13	85	105	110	13	800
174 PUR VKS/85/105/110/25	85	105	110	25	800
174 PUR VKS/85/110/115/25	85	110	115	25	850

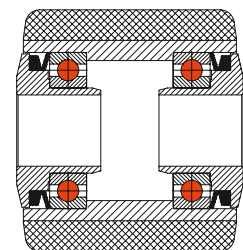

V-ring sealing gasket

PEVOPUR® - PEVOPLASTIC®  
PEVOHAN®

Solid rubber  
wheels and castors

Electrically conductive  
wheels and castors

VULKOLLAN® - PEVOPUR®  
PEVOVHM® - Soft

Stainless steel castors

Institutional  
wheels and castors

Conveyor/guiding  
rollers and ball units

Profile rollers

Pallet rollers

Press-on tyres

# PE·VO·DYN®-Soft pallet rollers



Series 174 PD-S

## PEVODYN®-Soft pallet rollers with sealed ball bearings

Roller body made of steel tube with ball bearings. Direct bonded PEVODYN®-Soft tread (78° Shore A). Plastic sealing and V-ring gasket for protection of the ball bearings against splash water and foreign matter.

Article code	mm	mm	mm	mm	kg
174 PD-S KS/82/060/064,7/20	82	60	64,7	20	360
174 PD-S KS/82/070/074/20	82	70	74	20	420
174 PD-S KS/82/100/104,7/20	82	100	104,7	20	600
174 PD-S KS/85/073/078/20	85	73	78	20	450
174 PD-S KS/85/074/076/13	85	74	76	13	460
174 PD-S VKS/85/070/075/20	85	70	75	20	430
174 PD-S VKS/85/075/080/25	85	75	80	25	460
174 PD-S VKS/85/080/085/12	85	80	85	13	490
174 PD-S VKS/85/085/089,7/13	85	85	89,7	13	530
174 PD-S VKS/85/095/100/20	85	95	100	20	590
174 PD-S VKS/85/100/105/25	85	100	105	25	620
174 PD-S VKS/85/110/115/25	85	110	115	25	680
174 PD-S/82/070/070/20	82	70	70	20	420
174 PD-S/85/080/082/17	85	80	82	17	490
174 PD-S/85/090/094/20	85	90	94	20	560
174 PD-S/85/100/102/25	85	100	102	25	620

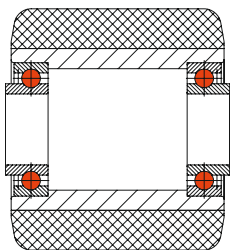

ZZV-ball bearing

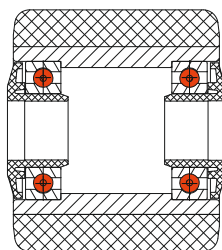

KS-sealing

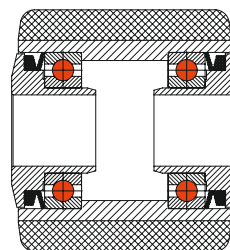

V-ring sealing gasket

PEVODYN® - PEVODYN®  
PEVODYN®

Solid rubber  
wheels and castors

Electrically conductive  
wheels and castors

VULKOLLAN® - PEVOPUR®  
PEVODYN® - Soft

Stainless steel castors

Institutional  
wheels and castors

Conveyor/guiding  
rollers and ball units

Profile rollers

Pallet rollers

Press-on tyres

# VULKOLLAN®/PE·VO·PUR®/ Solid rubber press-on tyres



PEVOLLAN® • PEVOPLASTIC® PEVOTHAN®
Solid rubber wheels and castors
Electrically conductive wheels and castors
VULKOLLAN® • PEVOPUR® PEVODYN® / -Soft
Stainless steel castors
Institutional wheels and castors
Conveyor/guiding rollers and ball units
Profile rollers
Puller rollers
Press-on tyres

# VULKOLLAN®/PE·VO·PUR®/ Solid rubber press-on tyres product overview

## Press-on tyres

We produce one of the most comprehensive range of VULKOLLAN® and PEVOPUR® press-on tyres. We also offer an extensive product range of solid rubber press-on tyres with a wide variety of dimensions and load capacities.

Cylindrical steel band tyres are produced as standard products with diameters ranging from 100 mm to 920 mm and load capacities of more than 18.5 t.

In order to ensure a better pressing on of the cylindrical steel band tyres, every inner ring is measured, turned and produced with slightly smaller dimensions to fit size h11.



Series 179 Z  
280 - 18.500 kg  
[Page 166 - 167](#)

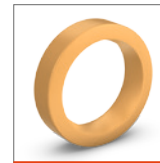

Series 179 K  
540 - 5.400 kg  
[Page 168](#)



Series 179 Z PUR  
640 - 12.650 kg  
[Page 169](#)



Series 79 D  
Series 79 K  
160 - 2.250 kg  
[Page 170](#)



Series 79 S  
250 - 12.420 kg  
[Page 171](#)

# VULKOLLAN® press-on tyres



Series 179 Z

## VULKOLLAN® press-on tyres

Cylindrical VULKOLLAN® press-on tyres (93° Shore A) with machined steel band for rims with fit h11.

Article code	D mm	W mm	d mm	kg
179 Z/100/032/075	100	32	75	280
179 Z/100/043/055	100	43	55	390
179 Z/100/070/055	100	70	55	600
179 Z/125/040/075	125	40	75	420
179 Z/125/050/075	125	50	75	540
179 Z/150/040/100	150	40	100	520
179 Z/150/050/100	150	50	100	640
179 Z/150/065/100	150	65	100	820
179 Z/150/075/100	150	75	100	960
179 Z/150/100/085	150	100	85	1.260
179 Z/150/130/100	150	130	100	1.640
179 Z/160/050/100	160	50	100	730
179 Z/160/075/100	160	75	100	1.020
179 Z/180/050/120	180	50	120	760
179 Z/180/075/120	180	75	120	1.140
179 Z/180/100/105	180	100	105	1.520
179 Z/200/050/140	200	50	140	840
179 Z/200/060/150	200	60	150	1.020
179 Z/200/070/140	200	70	140	1.180
179 Z/200/075/100	200	75	100	1.370
179 Z/200/080/120	200	80	120	1.360
179 Z/200/085/105	200	85	105	1.440
179 Z/200/105/120	200	105	120	1.780
179 Z/230/050/170	230	50	170	980
179 Z/230/075/170	230	75	170	1.460
179 Z/230/085/170	230	85	170	1.660
179 Z/250/050/190	250	50	190	1.060
179 Z/250/060/190	250	60	190	1.260
179 Z/250/075/140	250	75	140	1.580
179 Z/250/080/170	250	80	170	1.680
179 Z/250/100/170	250	100	170	2.100
179 Z/250/105/170	250	105	170	2.220
179 Z/250/105/190	250	105	190	2.220
179 Z/250/130/140	250	130	140	2.740
179 Z/254/076/203	254,0 (10")	76,0 (3")	203,0 (8")	1.640
179 Z/254/102/165	254,0 (10")	102,0 (4")	165,0 (6 ½")	2.180
179 Z/254/127/165	254,0 (10")	127,0 (5")	165,0 (6 ½")	2.720
179 Z/260/085/170	260	85	170	1.860
179 Z/260/105/170	260	105	170	2.300
179 Z/267/089/203	267,0 (10 ½")	89,0 (3 ½")	203,0 (8")	2.000
179 Z/285/075/220	285	75	220	1.800
179 Z/285/100/200	285	100	200	2.400
179 Z/285/100/220	285	100	220	2.400
179 Z/285/100/228	285	100	228	2.400
179 Z/290/105/185	290	105	185	2.560
179 Z/300/050/240	300	50	240	1.260
179 Z/300/075/240	300	75	240	1.800

PEVOLON® - PEVOPLASTIC®  
PEVOTHA®

Solid rubber  
wheels and castors

Electrically conductive  
wheels and castors

VULKOLLAN® - PEVOPLUR®  
PEVODIN® - Soft

Stainless steel castors

Institutional  
wheels and castors

Conveyor/guiding  
rollers and ball units

Profile rollers

Pallet rollers

Press-on tyres

# VULKOLLAN® press-on tyres

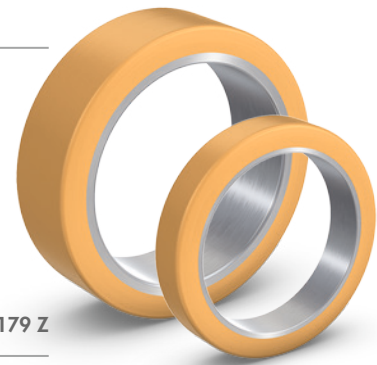

Series 179 Z

Article code	D mm	W mm	d mm	kg
179 Z/300/090/203	300	90	203	2.160
179 Z/300/100/203	300	100	203	2.750
179 Z/310/060/220	310	60	220	1.480
179 Z/310/120/203	310	120	203	2.980
179 Z/310/120/220	310	120	220	2.980
179 Z/330/089/203	330,0 (13")	89,0 (3 1/2")	203,0 (8")	2.100
179 Z/330/089/254	330,0 (13")	89,0 (3 1/2")	254,0 (10")	2.350
179 Z/330/127/254	330,0 (13")	127,0 (5")	254,0 (10")	3.350
179 Z/330/145/193,5	330	145	193,5	3.820
179 Z/343/114/225	343	114	225	3.120
179 Z/345/115/245	345	115	245	3.340
179 Z/350/090/280	350	90	280	2.600
179 Z/350/100/280	350	100	280	2.800
179 Z/350/110/270	350	110	270	3.080
179 Z/350/140/270	350	140	270	3.920
179 Z/360/075/270	360	75	270	2.470
179 Z/360/085/270	360	85	270	2.450
179 Z/381/127/286	381,0 (15")	127,0 (5")	286,0 (11 1/4")	3.860
179 Z/400/075/305	400	75	305	2.750
179 Z/405/065/305	405	65	305	2.100
179 Z/405/130/290	405	130	290	3.800
179 Z/405/130/305	405	130	305	4.000
179 Z/405/145/290	405	145	290	4.100
179 Z/406/178/305	406	178	305	5.400
179 Z/415/075/305	415	75	305	2.500
179 Z/415/090/305	415	90	305	3.000
179 Z/415/100/305	415	100	305	3.370
179 Z/445/178/381	445,0 (17 1/2")	178,0 (7")	381,0 (15")	6.000
179 Z/457/127/308	457,0 (18")	127,0 (5")	308,0 (12 1/4")	4.650
179 Z/457/152/308	457,0 (18")	152,0 (6")	308,0 (12 1/4")	4.950
179 Z/457/178/308	457,0 (18")	178,0 (7")	308,0 (12 1/4")	5.400
179 Z/500/085/370	500	85	370	3.000
179 Z/500/100/370	500	100	370	3.660
179 Z/500/140/370	500	140	370	5.130
179 Z/559/152/406	559,0 (22")	152,0 (6")	406,0 (16")	5.950
179 Z/559/203/406	559,0 (22")	203,0 (8")	406,0 (16")	8.000
179 Z/559/229/406	559,0 (22")	229,0 (9")	406,0 (16")	8.950
179 Z/610/150/410	610	150	410	6.400
179 Z/645/250/500	645	250	500	11.300
179 Z/660/127/508	660,0 (26")	127,0 (5")	508,0 (20")	6.550
179 Z/711/203/559	711,0 (28")	203,0 (8")	559,0 (22")	10.100
179 Z/711/254/559	711,0 (28")	254,0 (10")	559,0 (22")	12.650
179 Z/711/305/559	711,0 (28")	305,0 (12")	559,0 (22")	15.200
179 Z/750/150/640	750	150	640	7.880
179 Z/900/200/670	900	200	670	12.600
179 Z/920/180/770 U9	920	180	770	11.600
179 Z/920/290/770	920	290	770	18.500

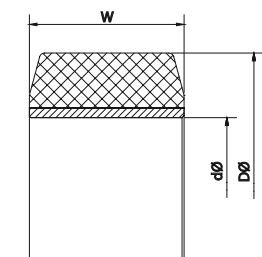

PEVOLON® - PEVOPLASTIC®  
PEVOTHA®

Solid rubber  
wheels and castors

Electrically conductive  
wheels and castors

VULKOLLAN® - PEVOPLUR®  
PEVODIN® - Soft

Stainless steel castors

Institutional  
wheels and castors

Conveyor/guiding  
rollers and ball units

Profile rollers

Puller rollers

Press-on tyres

# VULKOLLAN® press-on tyres

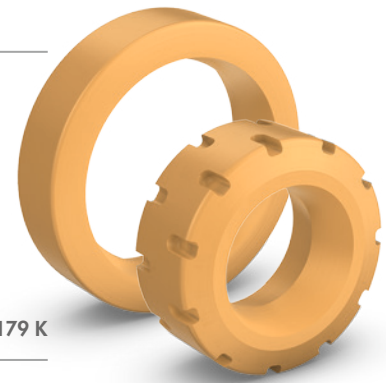

Series 179 K

Article code	mm	W mm	d mm	km/ks	kg
179 K/125/050/075	125	50	75	km 15	540
179 K/150/050/100	150	50	100	km 15	640
179 K/160/050/100	160	50	100	km 15	680
179 K/180/050/120	180	50	120	km 15	760
179 K/180/100/105	180	100	105	km 08	1.520
179 K/200/050/140	200	50	140	km 15	840
179 K/200/085/105	200	85	105	km 15	1.440
179 K/200/085/105 P	200	85	105	km 15	1.440
179 K/250/060/170	250	60	170	km 15	1.260
179 K/285/100/200	285	100	200	km 08	2.400
179 K/300/075/220	300	75	220	km 15	1.800
179 K/310/075/200	310	75	200	km 15	1.860
179 K/343/114/225	343	114	225	km 08	3.120
179 K/300/096/231	300	96	231	ks 23/9	2.300
179 K/310/120/200	310	120	200	ks 15/6	2.980
179 K/343/140/225	343	140	225	ks 15/6	3.840
179 K/406/178/267	406	178	267	ks 15/6	5.400

P = tread

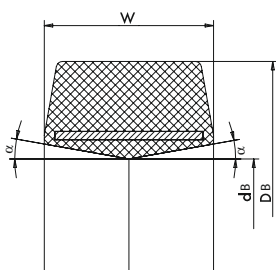

**km = conical base tyre  
centre split (symmetrical)**

km 15 =  $\alpha$  15°  
km 8 =  $\alpha$  8°

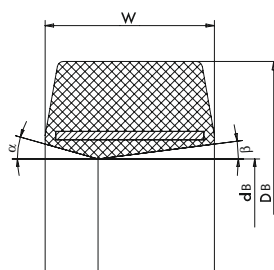

**ks = conical base tyre  
laterally split (asymmetrical)**

ks 15/6 =  $\alpha$  15°,  $\beta$  6°  
ks 23/9 =  $\alpha$  23°,  $\beta$  9°

## VULKOLLAN® press-on tyres

VULKOLLAN® press-on tyres (93° Shore A) with cast-in steel band. With conical base tyre, centre split (km) or laterally split (ks).

PEVOLON® - PEVOLASTIC®  
PEVOTHA®

Solid rubber  
wheels and castors

Electrically conductive  
wheels and castors

VULKOLLAN® - PEVOPUR®  
PEVDIV® / -Soft

Stainless steel castors

Institutional  
wheels and castors

Conveyor/guiding  
rollers and ball units

Profile rollers

Puller rollers

Press-on tyres

# PE·VO·PUR® press-on tyres

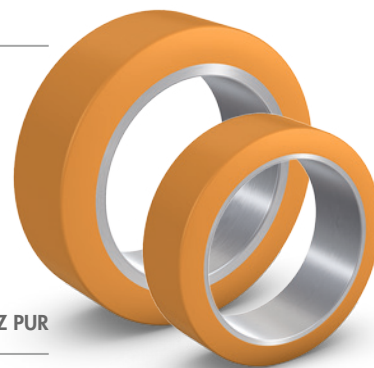

Series 179 Z PUR

Article code	mm	W mm	d mm	kg
179 Z PUR/150/050/100	150	50	100	640
179 Z PUR/150/075/100	150	75	100	960
179 Z PUR/180/050/120	180	50	120	760
179 Z PUR/180/075/120	180	75	120	1.140
179 Z PUR/200/050/140	200	50	140	840
179 Z PUR/200/075/100	200	75	100	1.260
179 Z PUR/230/050/170	230	50	170	980
179 Z PUR/230/075/170	230	75	170	1.460
179 Z PUR/230/085/170	230	85	170	1.660
179 Z PUR/250/050/190	250	50	190	1.060
179 Z PUR/250/060/190	250	60	190	1.260
179 Z PUR/250/080/170	250	80	170	1.680
179 Z PUR/250/130/140	250	130	140	2.740
179 Z PUR/254/076/203	254,0 (10")	76,0 (3")	203,0 (8")	1.640
179 Z PUR/254/102/165	254,0 (10")	102,0 (4")	165,0 (6 ")	2.180
179 Z PUR/254/120/190	254	120	190	2.560
179 Z PUR/254/127/165	254,0 (10")	127,0 (5")	165,0 (6 ½")	2.720
179 Z PUR/267/089/203	267,0 (10 ½")	89,0 (3 ½")	203,0 (8")	2.000
179 Z PUR/285/100/200	285	100	200	2.400
179 Z PUR/285/100/228	285	100	228	2.400
179 Z PUR/305/127/203	305,0 (12")	127,0 (5")	203,0 (8")	3.100
179 Z PUR/318/076/254	318,0 (12 ½")	76,0 (3")	254,0 (10")	1.920
179 Z PUR/318/089/254	318,0 (12 ½")	89,0 (3 ½")	254,0 (10")	2.260
179 Z PUR/330/089/254	330,0 (13")	89,0 (3 ½")	254,0 (10")	2.350
179 Z PUR/330/140/241	330,0 (13")	140,0 (5 ½")	241,0 (9 ½")	3.680
179 Z PUR/345/140/245	345	140	245	3.860
179 Z PUR/350/100/280	350	100	280	2.800
179 Z PUR/381/127/286	381,0 (15")	127,0 (5")	286,0 (11 ¼")	3.860
179 Z PUR/405/130/305	405	130	305	4.000
179 Z PUR/500/085/370	500	85	370	3.000
179 Z PUR/550/160/410	550	160	410	6.100
179 Z PUR/559/203/406	559,0 (22")	203,0 (8")	406,0 (16")	8.000
179 Z PUR/559/254/406	559,0 (22")	254,0 (10")	406,0 (16")	9.900
179 Z PUR/711/203/559	711,0 (28")	203,0 (8")	559,0 (22")	10.100
179 Z PUR/711/254/559	711,0 (28")	254,0 (10")	559,0 (22")	12.650

## PEVOPUR® press-on tyres

Cylindrical PEVOPUR® press-on tyres (93° Shore A) with machined steel band for rims with fit h11.

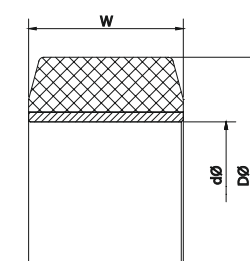

PEVOPUR® - PEVOLAISTIC®  
PEVOTHA®

Solid rubber  
wheels and castors

Electrically conductive  
wheels and castors

VULKOLLAN® - PEVOPUR®  
PEVODYN® - Soft

Stainless steel castors

Institutional  
wheels and castors

Conveyor/guiding  
rollers and ball units

Profile rollers

Pallet rollers

Press-on tyres







# Solid rubber **press-on** tyres









Series 79 K

Series 79 D

 Article code	 D mm	 W mm	 d mm	 kg
79 D/125/050/075 L	125	50	75	160
79 D/150/050/100 L	150	50	100	225
79 D/160/050/100 L	160	50	100	250
79 D/180/050/120 L	180	50	120	325
79 D/200/050/140 L	200	50	140	350
79 D/230/050/170 L	230	50	170	400
79 D/250/050/190 L	250	50	190	450
79 D/250/060/190 L	250	60	190	525
79 D/250/080/170 L	250	80	170	675
79 D/280/075/220 A	280	75	220	725
79 D/300/075/220 L	300	75	220	725
79 D/300/090/203 L	300	90	203	900
79 D/310/060/220 L	310	60	220	650
79 D/360/060/270 L	360	60	270	750
79 D/400/065/305 L	400	65	305	900
79 D/400/075/305 L	400	75	305	1.000
79 D/405/130/305 L	405	130	305	1.500
79 D/500/085/370 L	500	85	370	1.300
79 D/610/150/410 A	610	150	410	2.250
79 D/750/075/640 A	750	75	640	1.750

## Solid rubber press-on tyres

Cylindrical with steel wire core and plain profile. Solid rubber press-on-tyres with cross-country profile or non-marking are available on request.

 Article code	 D mm	 W mm	 d mm	 km/ks	 kg
79 K/125/050/075 L	125	50	75	km 15	160
79 K/160/050/100 L	160	50	100	km 15	250
79 K/180/050/120 A	180	50	120	km 15	325
79 K/200/050/140 L	200	50	140	km 15	350
79 K/200/085/105 A	200	85	105	km 15	550
79 K/250/075/140 L	250	75	140	km 15	625
79 K/260/060/170 L	260	60	170	km 15	525
79 K/300/100/203 L	300	100	203	km 08	975
79 K/360/060/270 L	360	60	270	km 15	750
79 K/310/120/200 A	310	120	200	ks 15/6	1.050
79 K/343/140/203 A	343,0 (13 ½")	140,0 (5 ½")	203,0 (8")	ks 15/6	1.350
79 K/406/127/267 A	406,0 (16")	127,0 (5")	267,0 (10 ½")	ks 15/6	1.350
79 K/406/152/267 A	406,0 (16")	152,0 (6")	267,0 (10 ½")	ks 15/6	1.575

## Solid rubber press-on tyres

Conical with steel wire core and plain profile.

Cross-section, see page 168.

A = drive wheel quality L = running wheel quality

# Solid rubber **press-on** tyres



Series 79 S

Article code	D mm	W mm	d mm	kg
79 S/160/050/100 A	160	50	100	250
79 S/180/050/120 A	180	50	120	325
79 S/200/050/140 A	200	50	140	350
79 S/200/085/105 A	200	85	105	550
79 S/230/050/170 A	230	50	170	400
79 S/250/050/190 A	250	50	190	450
79 S/250/060/190 A	250	60	190	525
79 S/250/080/170 A	250	80	170	675
79 S/250/075/140 A	250	75	140	625
79 S/250/105/170 A	250	105	170	845
79 S/250/130/140 A	250	130	140	975
79 S/254/102/165 A	254,0 (10")	102,0 (4")	165,0 (6 ½")	850
79 S/270/105/170 A	270	105	170	900
79 S/285/075/220 A	285	75	220	725
79 S/285/100/203 A	285	100	203	960
79 S/300/075/240 A	300	75	240	700
79 S/300/090/203 A	300	90	203	900
79 S/405/065/305 A	405	65	305	900
79 S/405/130/305 A	405	130	305	1.500
79 S/415/075/305 A	415	75	305	1.000
79 S/425/150/305 A	425	150	305	1.910
79 S/457/203/308 A	457,0 (18")	203,0 (8")	308,0 (12 ½")	3.000
79 S/457/229/308 A	457,0 (18")	229,0 (9")	308,0 (12 ½")	3.710
79 S/520/120/370 A	520	120	370	1.775
79 S/550/160/410 A	550	160	410	2.250
79 S/610/150/410 A	610	150	410	2.500
79 S/620/200/410 A	620	200	410	3.785
79 S/660/250/480 A	660	250	480	3.750
79 S/680/150/470 A	680	150	470	2.500
79 S/711/254/559 A	711	254	559	4.375
79 S/1016/305/762 A	1016	305	762	8.760
79 S/1016/406/762 A	1016	406	762	12.420

## Solid rubber press-on tyres

Cylindrical with steel ring in drive wheel quality and with plain profile. Solid rubber press-on tyres with cross country profile or non-marking are available on request.

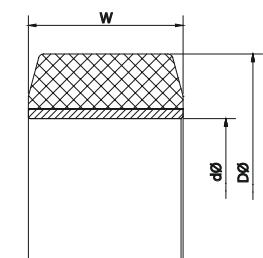

A = drive wheel quality

# Safety relevant product information

Dear customer,

**For safety reasons, it is imperative to strictly adhere to the following information about wheels and castors.** Please check it carefully. Please arrange for all persons getting in contact with the products to be aware of this information, too. In the event of any lack of clarity, we are always at your disposal for any further information. In this case, please refrain from further use of the products until clarity has been achieved. In the event of damage or loss due to non-observance of this information, a liability of the manufacturer is excluded.

## 1.0 Product information and intended use

Wheels and castors in the sense of this definition are components, which can in general be exchanged and can be fitted to appliances, furniture and transport systems or any similar products intended for this use to make them mobile.

This product information refers to wheels and castors, especially passive steering castors (swivel castors), for vehicles and appliances which are not machine driven, hereafter called objects, which are usually not driven faster than walking speed and are not in continuous operation.

Wheels and castors in the sense of this product information can be classified into the following fields of application:

Living quarters	e.g. seating furniture, home furniture
Services	
· general services	e.g. shopping carts, office machines
· hospitals	e.g. hospital beds
Industry	e.g. transport equipment, medium and heavy load capacity

Correct mounting is an important factor for the intended use:

- The product must be firmly connected to the object at all points intended for this.
- The object must be of sufficient stability at these points.
- The function of the product must not be impaired or modified by the mounting.
- The swivel bearing king pin axis must be vertical at all times.
- Fixed castors must be mounted in such a way that the axles are in alignment.
- On one object, swivel castors of the same design are to be used. If fixed castors are mounted, too, only castors recommended by the manufacturer are to be used.

Specially designed products must be specified for humid environments, if subject to direct weather exposure, near the sea or for use in aggressive, corrosion-developing environments.

Specially designed products must be specified for use at temperature ranges below 5 °C and above 30 °C. Under these conditions, standard products must under no circumstances be operated at their nominal load.

Wheel, bracket, brake system and axle components form one functional unit. Liability only exists for our original products.

All possible loads must be known when selecting the castors. Otherwise these must be taken into account with an increased safety factor.

## 2.0 Misuse

There is product misuse – i.e. wheels and castors are not operated according to their intended use – if

- wheels and castors are operated with a higher load than the max. load capacity specified in the catalogue.
- they are used on unsuitable, uneven floors.
- the ambient temperature is too high or too low.
- the equipment is moved by force while the wheels are locked.
- especially aggressive media can affect them.
- improper shock loading takes effect.
- foreign matter can penetrate the tyres.
- the wheels and castors are used at excessive speed.
- modifications are carried out which have not been agreed to by the manufacturer.

## 3.0 Product characteristics

Unless the product characteristics have been precisely defined in our catalogues, leaflets, specifications etc., the demands made on our wheels and castors or their components must be agreed with us.

As a guideline, the relevant DIN, EN and ISO standards apply.

## 4.0 Product maintenance

Depending on the requirements, wheels and castors must be serviced regularly

- by lubricating the bearings
- by readjusting any detachable connections.

Only cleaning agents which do not contain any corrosive or damaging components may be used.

As soon as malfunctions occur, castors or their components must be replaced.

## 5.0 Duty to inform and instruct















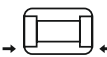

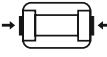





















In order to fulfil the duties to inform and instruct as well as for carrying out maintenance work according to the product liability law the following documentation is available:

- for the trade: catalogues with product and user information
- for the manufacturer: catalogues with product and user information
- for the user: product and user information

In order to guarantee the function of wheels and castors

- the trade is obliged to observe this product information (point 1.0 – 5.0) and the user information, to request them from the producer if required and to hand them over to the manufacturer.
- the manufacturers are obliged to observe this product information (point 1.0 – 5.0) and the user information, to request them from the producer or the trade if required and to hand it over to the user.

# Pictographs

	Article code	<b>Pallet rollers</b>		<b>Single-flanged wheels</b>	
	Load capacity (kg)		Roller diameter		Overall width
<b>Wheels</b>			Roller width		Tread width
	Wheel diameter		Fixing length		Fitting depth
	Wheel width	<b>Press-on tyres</b>			Hub length
	Fixing length		Outer diameter		Hub diameter
	Hub length		Tread width	<b>Double-flanged wheels</b>	
	Hub diameter		Inner diameter		Tread width
	Bore hole diameter		Center and side split degree		Hub length
<b>Castors</b>		<b>Grooved wheels</b>			Hub diameter
	Overall height		Flange diameter		Groove width
	Top plate size		Tread diameter		Groove depth
	Bolt hole spacing		Tread width		
	Bolt hole diameter		Hub length		
	Offset		Hub diameter		
	Minimum circumscribed circle		Grooved width		
	Single bolt hole diameter		Bore diameter		

---

# Contact details

---

## **Berlin**

Pankstraße 8-10  
13127 Berlin, Germany  
Tel.: +49 30 4749888-0  
Fax: +49 30 4749888-22  
berlin@raedervogel.de

## **Hamburg**

Amsinckstraße 2  
20097 Hamburg, Germany  
Tel.: +49 40 236880-49/50  
Fax: +49 40 236880-51  
hamburg@raedervogel.de

## **Rheinland**

Walter-Frese-Straße 17  
42799 Leichlingen, Germany  
Tel.: +49 2175 99040-0  
Fax: +49 2175 99040-22  
rheinland@raedervogel.de

## **Dornstadt**

Spatzenweg 6  
89160 Dornstadt, Germany  
Tel.: +49 7304 803950  
Fax: +49 7304 803959  
dornstadt@raedervogel.de

# RÄDER-VOGEL®

FOR BETTER WHEELS AND BETTER SERVICE



## **RÄDER-VOGEL**

RÄDER- UND ROLLENFABRIK GMBH & CO. KG  
Sperlsdeicher Weg 19-23 • 21109 Hamburg • Germany  
Tel.: +49 40 75499-0 • Fax: +49 40 75499-175

[www.raedervogel.de](http://www.raedervogel.de) • [rv@raedervogel.de](mailto:rv@raedervogel.de)